

FUJIFILM

DIGITAL CAMERA

X-S10

FF200001

Owner's Manual

Introduction

Thank you for your purchase of this product. Be sure that you have read this manual and understood its contents before using the camera. Keep the manual where it will be read by all who use the product.

For the Latest Information

The latest versions of the manuals are available from:

<http://fujifilm-dsc.com/en/manual/>



The site can be accessed not only from your computer but also from smartphones and tablets. It also contains information on the software license.



For information on firmware updates, visit:

<https://fujifilm-x.com/support/download/firmware/cameras/>



Chapter Index

Menu List	iv
1 Before You Begin	1
2 First Steps	27
3 Basic Photography and Playback	41
4 Movie Recording and Playback	47
5 Taking Photographs	55
6 The Shooting Menus	105
7 Playback and the Playback Menu	179
8 The Setup Menus	205
9 Shortcuts	241
10 Peripherals and Optional Accessories	257
11 Connections	275
12 Technical Notes	291

Menu List



Camera menu options are listed below.



















Shooting Menus





Adjust settings when shooting photos or movies.

 See page 105 for details.





Photo Menus























 Items marked with both  and  icons are available in both the still photography and movie shooting menus. Changes to these items in either menu also apply to the item in the remaining menu.















 IMAGE QUALITY SETTING		 AF/MF SETTING	
IMAGE SIZE	106	FOCUS AREA	122
IMAGE QUALITY	107	FOCUS MODE	122
RAW RECORDING	108	AF MODE	122
FILM SIMULATION	108	AF-C CUSTOM SETTINGS	123
$\frac{1}{3}$ MONOCHROMATIC COLOR	110	$\frac{1}{3}$ STORE AF MODE BY ORIENTATION	127
GRAIN EFFECT	110	AF POINT DISPLAY  	127
COLOR CHROME EFFECT	110	NUMBER OF FOCUS POINTS	127
COLOR CHROME FX BLUE	111	PRE-AF	128
WHITE BALANCE	111	  AF ILLUMINATOR	128
DYNAMIC RANGE	115	FACE/EYE DETECTION SETTING	129
D RANGE PRIORITY	116	AF+MF	131
$\frac{2}{3}$ TONE CURVE	116	$\frac{2}{3}$ MF ASSIST	132
$\frac{2}{3}$ COLOR	117	$\frac{2}{3}$ FOCUS CHECK	132
SHARPNESS	117	INTERLOCK SPOT AE & FOCUS AREA	133
HIGH ISO NR	117	  INSTANT AF SETTING	133
CLARITY	118	  DEPTH-OF-FIELD SCALE	133
LONG EXPOSURE NR	118	RELEASE/FOCUS PRIORITY	134
LENS MODULATION OPTIMIZER	118	$\frac{3}{5}$   AF RANGE LIMITER	134
$\frac{3}{5}$ COLOR SPACE	119	  TOUCH SCREEN MODE	135
$\frac{3}{5}$ PIXEL MAPPING	119		
EDIT/SAVE CUSTOM SETTING	120		
  MOUNT ADAPTOR SETTING	120		

1/3	SHOOTING SETTING		FLASH SETTING	
	SCENE POSITION	137	FLASH FUNCTION SETTING	148
	FILTER SETTING	137	RED EYE REMOVAL	148
	SPORTS FINDER MODE	138	TTL-LOCK MODE	149
	PRE-SHOT ES 	138	LED LIGHT SETTING	149
	SELF-TIMER	139	COMMANDER SETTING	150
	SAVE SELF-TIMER SETTING	139	CH SETTING	150
	SELF-TIMER LAMP	140	MOVIE SETTING	
	INTERVAL TIMER SHOOTING	140	MOVIE MODE	151
	INTERVAL TIMER SHOOTING EXPOSURE SMOOTHING	141	FILE FORMAT	151
2/3	AE BKT SETTING	142	FULL HD HIGH SPEED REC	151
	FILM SIMULATION BKT	142	 IS MODE	151
	FOCUS BKT SETTING	143	 IS MODE BOOST	151
	PHOTOMETRY	143	AUDIO SETTING	152
	SHUTTER TYPE	144	MIC/REMOTE RELEASE	153
	FLICKER REDUCTION	145		
	IS MODE	146		
3/3	ISO	146		
	 WIRELESS COMMUNICATION	147		

Movie Menu

  Items marked with both  and  icons are available in both the still photography and movie shooting menus. Changes to these items in either menu also apply to the item in the remaining menu.



 MOVIE SETTING		 IMAGE QUALITY SETTING	
SHOOTING MODE	154	 FILM SIMULATION	163
MOVIE MODE	154	 MONOCHROMATIC COLOR	163
FILE FORMAT	155	 WHITE BALANCE	163
FULL HD HIGH SPEED REC	156	 DYNAMIC RANGE	164
$\frac{1}{3}$ FIX MOVIE CROP MAGNIFICATION <small>CROP 1.29x</small>	157	$\frac{1}{2}$  TONE CURVE	164
F-Log RECORDING	157	 COLOR	164
4K MOVIE OUTPUT	158	 SHARPNESS	165
FULL HD MOVIE OUTPUT	158	 HIGH ISO NR	165
HDMI OUTPUT INFO DISPLAY	159	$\frac{2}{3}$  INTERFRAME NR	165
4K HDMI STANDBY QUALITY	159	 PERIPHERAL LIGHT CORRECTION	166
HDMI REC CONTROL	159	  MOUNT ADAPTOR SETTING	166
$\frac{2}{3}$  PHOTOMETRY	159		
 IS MODE	160		
 IS MODE BOOST	160		
 ISO	161		
ZEBRA SETTING	161		
ZEBRA LEVEL	161		
$\frac{3}{3}$ MOVIE OPTIMIZED CONTROL 	161		
TALLY LIGHT	162		
  WIRELESS COMMUNICATION	162		



AF/MF SETTING		AUDIO SETTING	
 FOCUS AREA	167	INTERNAL MIC LEVEL ADJUSTMENT	174
 FOCUS MODE	167	EXTERNAL MIC LEVEL ADJUSTMENT	174
 AF MODE	167	MIC JACK SETTING	175
1/2  AF-C CUSTOM SETTING	168	MIC LEVEL LIMITER	175
 AF ILLUMINATOR	168	WIND FILTER	175
 FACE/EYE DETECTION SETTING	169	LOW CUT FILTER	175
 MF ASSIST	169	HEADPHONES VOLUME	175
 FOCUS CHECK	170	MIC/REMOTE RELEASE	176
 INSTANT AF SETTING	170	TC TIME CODE SETTING	
 DEPTH-OF-FIELD SCALE	170	TIME CODE DISPLAY	177
2/2  AF RANGE LIMITER	170	START TIME SETTING	177
 TOUCH SCREEN MODE	171	COUNT UP SETTING	177
FOCUS CHECK LOCK	173	DROP FRAME	178
		HDMI TIME CODE OUTPUT	178

The Playback Menu

Adjust playback settings.

 See page 185 for details.









 PLAY BACK MENU	
RAW CONVERSION	185
ERASE	188
CROP	190
RESIZE	191
PROTECT	192
IMAGE ROTATE	193
RED EYE REMOVAL	194
VOICE MEMO SETTING	195

 PLAY BACK MENU	
RATING	196
IMAGE TRANSFER ORDER	197
 WIRELESS COMMUNICATION	198
SLIDE SHOW	198
PHOTOBOOK ASSIST	199
PC AUTO SAVE	200
PRINT ORDER (DPOF)	201
instax PRINTER PRINT	202
DISP ASPECT	203

Setup Menu

Adjust basic camera settings.

 See page 205 for details.

USER SETTING		SCREEN SETTING	
FORMAT	206	VIEW MODE SETTING	213
DATE/TIME	207	EVF BRIGHTNESS	213
TIME DIFFERENCE	207	EVF COLOR	213
1/2  言語/LANG.	208	EVF COLOR ADJUSTMENT	214
1/2  MY MENU SETTING	208	1/3 LCD BRIGHTNESS	214
1/2  MY MENU SETTING	208	LCD COLOR	214
SENSOR CLEANING	209	LCD COLOR ADJUSTMENT	214
SOUND & FLASH	209	IMAGE DISP.	215
2/2 RESET	210	AUTOROTATE DISPLAYS	215
2/2 REGULATORY	210	PREVIEW EXP./WB IN MANUAL MODE	216
SOUND SETTING		NATURAL LIVE VIEW	216
AF BEEP VOL.	211	2/3 F-Log VIEW ASSIST	217
SELF-TIMER BEEP VOL.	211	FRAMING GUIDELINE	217
OPERATION VOL.	212	AUTOROTATE PB	218
SHUTTER VOLUME	212	FOCUS SCALE UNITS	218
SHUTTER SOUND	212	APERTURE UNIT FOR CINEMA LENS	218
PLAYBACK VOLUME	212	DISP. CUSTOM SETTING	218
		LARGE INDICATORS MODE(EVF)	219
		LARGE INDICATORS MODE(LCD)	219
		3/3 LARGE INDICATORS DISP. SETTING	220
		INFORMATION CONTRAST ADJ.	220
		1/2  Q MENU BACKGROUND	221
		1/2  Q MENU BACKGROUND	221

1/2	BUTTON/DIAL SETTING		CONNECTION SETTING	
	FOCUS LEVER SETTING	:222	Bluetooth SETTINGS	:234
	EDIT/SAVE QUICK MENU	:223	PC AUTO SAVE	:235
	EDIT/SAVE QUICK MENU	:223	instax PRINTER CONNECTION SETTING	:236
	FUNCTION (Fn) SETTING	:223	CONNECTION MODE	:237
	SHUTTER AF	:224	USB POWER SUPPLY SETTING	:238
	SHUTTER AE	:224	GENERAL SETTINGS	:239
	SHOOT WITHOUT LENS	:225	INFORMATION	:239
	SHOOT WITHOUT CARD	:225	RESET WIRELESS SETTING	:239
	FOCUS RING	:225		
	FOCUS RING OPERATION	:225		
2 1/2	AE/AF-LOCK MODE	:226		
	AWB-LOCK MODE	:226		
	TOUCH SCREEN SETTING	:227		
	POWER MANAGEMENT			
	AUTO POWER OFF	:229		
	PERFORMANCE	:230		
	BOOST SETTING	:230		
	SAVE DATA SETTING			
	FRAME NO.	:231		
	SAVE ORG IMAGE	:232		
	EDIT FILE NAME	:232		
	SELECT FOLDER	:233		
	COPYRIGHT INFO	:233		



Table of Contents

Introduction	ii
For the Latest Information	ii
Menu List	iv
Shooting Menus	iv
The Playback Menu	viii
Setup Menus	ix
Supplied Accessories	xxiii
About This Manual	xxiv
Symbols and Conventions	xxiv
Terminology	xxiv

1 Before You Begin **1**

Parts of the Camera	2
Camera Functions	4
The Mode Dial	4
The Focus Stick (Focus Lever)	5
 (Drive) Button	5
The Command Dials	6
The Fn (Function) Dial	7
The Indicator Lamp	8
The LCD Monitor	9
Focusing the Viewfinder	9
Camera Displays	10
The Electronic Viewfinder	10
The LCD Monitor	12
Adjusting Display Brightness	14
Display Rotation	14
Choosing a Display Mode	14
The DISP/BACK Button	16
Customizing the Standard Display	17
Using the Menus	19
The Menus	19
Selecting a Menu Tab	20

Touch Screen Mode	21
Shooting Touch Controls	21
Playback Touch Controls	25

2 First Steps 27

Attaching the Strap	28
Attaching a Lens	29
Inserting the Battery and a Memory Card.....	30
Compatible Memory Cards	32
Charging the Battery.....	33
Turning the Camera On and Off.....	35
Checking the Battery Level.....	36
Basic Setup.....	37
Choosing a Different Language	39
Changing the Time and Date.....	39

3 Basic Photography and Playback 41

Taking Photographs	42
Viewing Pictures	44
Deleting Pictures	45

4 Movie Recording and Playback 47

Recording Movies.....	48
Recording Movies.....	48
Adjusting Movie Settings	51
Viewing Movies.....	52







5 Taking Photographs 55





Choosing a Shooting Mode.....	56
AUTO (AUTO)	56
Program AE (P).....	57
Shutter-Priority AE (S).....	58
Aperture-Priority AE (A)	60
Manual Exposure (M).....	62
SP SCENE POSITION	64





















FILTER	66
Custom Modes	67
The Command and Function Dials	69
Autofocus	70
Focus Mode	71
Autofocus Options (AF Mode)	73
Focus-Point Selection	75
Manual Focus	79
Checking Focus	80
Exposure Compensation	82
Sensitivity	83
Auto Sensitivity (A)	84
Metering	85
Focus/Exposure Lock	86
Other Controls	87
Bracketing	88
ISO ISO BKT	89
WB WHITE BALANCE BKT	89
BKT Bracketing	90
Continuous Shooting (Burst Mode)	93
HDR	94
Panoramas	96
Multiple Exposures	99
Flash Photography	101
Flash Settings	103











6 The Shooting Menus **105**

IMAGE QUALITY SETTING (Still Photography)	106
IMAGE SIZE	106
IMAGE QUALITY	107
RAW RECORDING	108
FILM SIMULATION	108
MONOCHROMATIC COLOR	110
GRAIN EFFECT	110
COLOR CHROME EFFECT	110

COLOR CHROME FX BLUE.....	111
WHITE BALANCE.....	111
DYNAMIC RANGE.....	115
D RANGE PRIORITY.....	116
TONE CURVE.....	116
COLOR.....	117
SHARPNESS.....	117
HIGH ISO NR.....	117
CLARITY.....	118
LONG EXPOSURE NR.....	118
LENS MODULATION OPTIMIZER.....	118
COLOR SPACE.....	119
PIXEL MAPPING.....	119
EDIT/SAVE CUSTOM SETTING.....	120
 MOUNT ADAPTER SETTING.....	120
AF/MF SETTING (Still Photography).....	122
FOCUS AREA.....	122
FOCUS MODE.....	122
AF MODE.....	122
AF-C CUSTOM SETTINGS.....	123
STORE AF MODE BY ORIENTATION.....	127
AF POINT DISPLAY 	127
NUMBER OF FOCUS POINTS.....	127
PRE-AF.....	128
 AF ILLUMINATOR.....	128
FACE/EYE DETECTION SETTING.....	129
AF+MF.....	131
MF ASSIST.....	132
FOCUS CHECK.....	132
INTERLOCK SPOT AE & FOCUS AREA.....	133
 INSTANT AF SETTING.....	133
 DEPTH-OF-FIELD SCALE.....	133
RELEASE/FOCUS PRIORITY.....	134
 AF RANGE LIMITER.....	134
 TOUCH SCREEN MODE.....	135

SHOOTING SETTING (Still Photography)	137
SCENE POSITION	137
FILTER SETTING.....	137
SPORTS FINDER MODE.....	138
PRE-SHOT 	138
SELF-TIMER.....	139
SAVE SELF-TIMER SETTING	139
SELF-TIMER LAMP	140
INTERVAL TIMER SHOOTING.....	140
INTERVAL TIMER SHOOTING EXPOSURE SMOOTHING	141
AE BKT SETTING.....	142
FILM SIMULATION BKT.....	142
FOCUS BKT SETTING.....	143
PHOTOMETRY	143
SHUTTER TYPE.....	144
FLICKER REDUCTION	145
IS MODE.....	146
ISO.....	146
 WIRELESS COMMUNICATION	147
FLASH SETTING (Still Photography)	148
FLASH FUNCTION SETTING.....	148
RED EYE REMOVAL	148
TTL-LOCK MODE.....	149
LED LIGHT SETTING.....	149
COMMANDER SETTING.....	150
CH SETTING.....	150
MOVIE SETTING (Still Photography)	151
MOVIE MODE.....	151
FILE FORMAT	151
FULL HD HIGH SPEED REC	151
 IS MODE.....	151
 IS MODE BOOST	151
AUDIO SETTING	152
MIC/REMOTE RELEASE.....	153

MOVIE SETTING (Movie Recording)	154
SHOOTING MODE.....	154
MOVIE MODE.....	154
FILE FORMAT	155
FULL HD HIGH SPEED REC	156
FIX MOVIE CROP MAGNIFICATION 	157
F-Log RECORDING.....	157
4K MOVIE OUTPUT	158
FULL HD MOVIE OUTPUT.....	158
HDMI OUTPUT INFO DISPLAY	159
4K HDMI STANDBY QUALITY.....	159
HDMI REC CONTROL.....	159
 PHOTOMETRY	159
 IS MODE.....	160
 IS MODE BOOST	160
 ISO.....	161
ZEBRA SETTING.....	161
ZEBRA LEVEL.....	161
MOVIE OPTIMIZED CONTROL 	161
TALLY LIGHT.....	162
 WIRELESS COMMUNICATION	162
IMAGE QUALITY SETTING (Movie Recording)	163
 FILM SIMULATION	163
 MONOCHROMATIC COLOR.....	163
 WHITE BALANCE.....	163
 DYNAMIC RANGE.....	164
 TONE CURVE	164
 COLOR	164
 SHARPNESS	165
 HIGH ISO NR.....	165
 INTERFRAME NR.....	165
 PERIPHERAL LIGHT CORRECTION	166
 MOUNT ADAPTER SETTING.....	166
AF/MF SETTING (Movie Recording)	167
 FOCUS AREA.....	167
 FOCUS MODE	167



 AF MODE	167
 AF-C CUSTOM SETTING	168
 AF ILLUMINATOR	168
 FACE/EYE DETECTION SETTING	169
 MF ASSIST	169
 FOCUS CHECK	170
 INSTANT AF SETTING	170
 DEPTH-OF-FIELD SCALE	170
 AF RANGE LIMITER	170
 TOUCH SCREEN MODE	171
FOCUS CHECK LOCK	173
AUDIO SETTING (Movie Recording)	174
INTERNAL MIC LEVEL ADJUSTMENT	174
EXTERNAL MIC LEVEL ADJUSTMENT	174
MIC JACK SETTING	175
MIC LEVEL LIMITER	175
WIND FILTER	175
LOW CUT FILTER	175
HEADPHONES VOLUME	175
MIC/REMOTE RELEASE	176
TIME CODE SETTING (Movie Recording)	177
TIME CODE DISPLAY	177
START TIME SETTING	177
COUNT UP SETTING	177
DROP FRAME	178
HDMI TIME CODE OUTPUT	178





7 Playback and the Playback Menu 179

The Playback Display	180
The DISP/BACK Button	181
Viewing Pictures	183
Playback Zoom	184
Multi-Frame Playback	184
The Playback Menu	185
RAW CONVERSION	185
ERASE	188

CROP	190
RESIZE	191
PROTECT	192
IMAGE ROTATE	193
RED EYE REMOVAL	194
VOICE MEMO SETTING	195
RATING	196
IMAGE TRANSFER ORDER	197
 WIRELESS COMMUNICATION	198
SLIDE SHOW	198
PHOTOBOOK ASSIST	199
PC AUTO SAVE	200
PRINT ORDER (DPOF)	201
instax PRINTER PRINT	202
DISP ASPECT	203

8 The Setup Menus 205

USER SETTING	206
FORMAT	206
DATE/TIME	207
TIME DIFFERENCE	207
 言語/LANG.	208
 MY MENU SETTING	208
 MY MENU SETTING	208
SENSOR CLEANING	209
SOUND & FLASH	209
RESET	210
REGULATORY	210
SOUND SETTING	211
AF BEEP VOL.	211
SELF-TIMER BEEP VOL.	211
OPERATION VOL.	212
SHUTTER VOLUME	212
SHUTTER SOUND	212
PLAYBACK VOLUME	212

SCREEN SETTING.....	213
VIEW MODE SETTING	213
EVF BRIGHTNESS.....	213
EVF COLOR.....	213
EVF COLOR ADJUSTMENT	214
LCD BRIGHTNESS.....	214
LCD COLOR.....	214
LCD COLOR ADJUSTMENT	214
IMAGE DISP.....	215
AUTOROTATE DISPLAYS	215
PREVIEW EXP./WB IN MANUAL MODE.....	216
NATURAL LIVE VIEW.....	216
F-Log VIEW ASSIST.....	217
FRAMING GUIDELINE.....	217
AUTOROTATE PB	218
FOCUS SCALE UNITS.....	218
APERTURE UNIT FOR CINEMA LENS	218
DISP. CUSTOM SETTING.....	218
LARGE INDICATORS MODE(EVF).....	219
LARGE INDICATORS MODE(LCD).....	219
LARGE INDICATORS DISP. SETTING.....	220
INFORMATION CONTRAST ADJ.	220
 Q MENU BACKGROUND.....	221
 Q MENU BACKGROUND.....	221
BUTTON/DIAL SETTING.....	222
FOCUS LEVER SETTING.....	222
 EDIT/SAVE QUICK MENU.....	223
 EDIT/SAVE QUICK MENU	223
FUNCTION (Fn) SETTING	223
SHUTTER AF	224
SHUTTER AE	224
SHOOT WITHOUT LENS.....	225
SHOOT WITHOUT CARD	225
FOCUS RING.....	225
FOCUS RING OPERATION.....	225

AE/AF-LOCK MODE.....	226
AWB-LOCK MODE.....	226
TOUCH SCREEN SETTING.....	227
POWER MANAGEMENT	229
AUTO POWER OFF.....	229
PERFORMANCE	230
BOOST SETTING.....	230
SAVE DATA SETTING	231
FRAME NO.....	231
SAVE ORG IMAGE.....	232
EDIT FILE NAME.....	232
SELECT FOLDER.....	233
COPYRIGHT INFO.....	233
CONNECTION SETTING	234
Bluetooth SETTINGS.....	234
PC AUTO SAVE	235
instax PRINTER CONNECTION SETTING	236
CONNECTION MODE.....	237
USB POWER SUPPLY SETTING.....	238
GENERAL SETTINGS.....	239
INFORMATION.....	239
RESET WIRELESS SETTING.....	239

9 Shortcuts 241

Shortcut Options	242
MY MENU	243
MY MENU SETTING.....	243
The Quick Menu.....	245
The Quick Menu Display	245
Viewing and Changing Settings.....	247
Editing the Quick Menu.....	248
Function Controls.....	251
The Function Buttons.....	251
The Function Dial.....	254
Touch-Function Gestures	255



10	Peripherals and Optional Accessories	257
	Lenses	258
	Lens Parts	258
	Removing Lens Caps	259
	Attaching Lens Hoods	259
	Lenses with Aperture Rings	260
	Lenses with O.I.S. Switches	261
	Manual Focus Lenses	262
	Lens Care	263
	External Flash Units	264
	Using an External Flash	265
	SYNC TERMINAL	266
	SHOE MOUNT FLASH	267
	COMMANDER(OPTICAL)	270
11	Connections	275
	HDMI Output	276
	Connecting to HDMI Devices	276
	Shooting	277
	Playback	277
	Wireless Connections (Bluetooth®, Wireless LAN/Wi-Fi)	278
	Smartphones and Tablets: FUJIFILM Camera Remote	278
	Copying Pictures to a Computer: PC AutoSave	280
	Connecting via USB	281
	Connecting to Computers	281
	Copying Pictures to a Computer	284
	Converting RAW Images: FUJIFILM X RAW STUDIO	285
	Backing up and Restoring Camera Settings (FUJIFILM X Acquire)	285
	Connecting to Smartphones	286
	instax SHARE Printers	289
	Establishing a Connection	289
	Printing Pictures	290



12	Technical Notes	291
	Accessories from Fujifilm	292
	Software for Use with Your Camera	294
	FUJIFILM Camera Remote	294
	FUJIFILM PC AutoSave	294
	RAW FILE CONVERTER EX powered by SILKYPIX	294
	Capture One Express Fujifilm	294
	Capture One Pro Fujifilm	295
	FUJIFILM X Acquire	295
	FUJIFILM X RAW STUDIO	295
	FUJIFILM X Webcam	295
	For Your Safety	296
	Product Care	305
	Cleaning the Image Sensor	306
	Firmware Updates	307
	Checking the Firmware Version	307
	Troubleshooting	308
	Warning Messages and Displays	317
	Memory Card Capacity	321
	Specifications	322

Supplied Accessories

The following are included with the camera:

- NP-W126S rechargeable battery
- Body cap (comes attached to camera)
- USB cable
- Headphone adapter
- Shoulder strap
- *Basic Manual*

 The battery is not charged at shipment. Charge the battery before use ( 33).



-  If you purchased a lens kit, check that a lens is included.
- The supplied headphone adapter converts USB Type-C connectors to ø3.5 mm headphone jacks.
- For information on compatible computer software, see “Software for Use with Your Camera” ( 294).

About This Manual

This manual contains instructions for your FUJIFILM X-S10 digital camera. Be sure you have read and understood its contents before proceeding.

Symbols and Conventions

The following symbols are used in this manual:

-  Information that should be read to prevent damage to the product.
-  Additional information that may be helpful when using the product.
-  Pages on which related information may be found.

Menus and other text in the displays are shown in **bold**. Illustrations are for explanatory purposes only; drawings may be simplified, while photographs are not necessarily taken with the model of camera described in this manual.

Terminology

The optional SD, SDHC, and SDXC memory cards the camera uses to store pictures are referred to as “memory cards”. The electronic viewfinder may be referred to as the “EVF” and the LCD monitor as the “LCD”.

Before You Begin



Parts of the Camera

The parts of the camera are listed below.

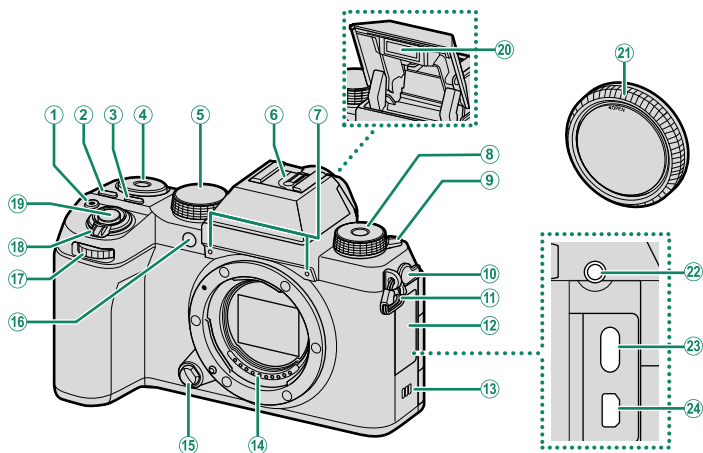

- | | | | | | |
|----|---------------------------------|-----------|----|---|-------------|
| 1 | ● (movie recording) button..... | 48 | 15 | Lens release button | 29 |
| 2 | Q (quick menu) button..... | 245 | 16 | AF-assist illuminator..... | 128 |
| 3 | ISO button..... | 251 | | Self-timer lamp | 139 |
| 4 | Rear command dial..... | 6, 183 | | Tally light..... | 162 |
| 5 | Mode dial..... | 4, 42, 48 | 17 | Front command dial..... | 6 |
| 6 | Hot shoe..... | 265 | 18 | ON/OFF switch | 35 |
| 7 | Microphone..... | 50, 174 | 19 | Shutter button..... | 43 |
| 8 | Fn (function) dial..... | 7, 254 | 20 | Flash..... | 101 |
| 9 | ⚡ (flash pop-up) lever..... | 101 | 21 | Body cap..... | 29 |
| 10 | Connector cover | | 22 | Microphone/remote release connector
($\varnothing 3.5$ mm)..... | 3, 50, 153 |
| 11 | Strap clip..... | 28 | 23 | USB connector (Type-C)..... | 33, 50, 281 |
| 12 | Connector cover | | 24 | HDMI Micro connector (Type D)..... | 276 |
| 13 | Speaker..... | 52, 212 | | | |
| 14 | Lens signal contacts | | | | |

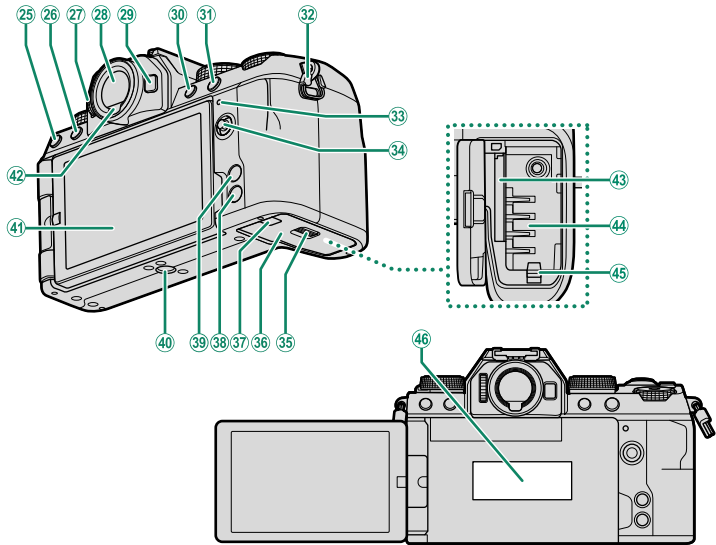

- | | | | |
|----|---|----|---|
| 25 | (drive) button..... 5, 88 | 35 | Battery-chamber cover latch..... 30 |
| 26 | (delete) button (playback mode)..... 45 | 36 | Battery-chamber cover..... 30 |
| 27 | (playback) button..... 44 | 37 | Cable channel cover for DC coupler..... 292 |
| 28 | Diopter adjustment control..... 9 | 38 | DISP (display)/ BACK button..... 16, 181 |
| 29 | Electronic viewfinder (EVF)
..... 10, 14, 16, 21 | 39 | MENU/OK button..... 19 |
| 30 | Fn button..... 251 | 40 | Tripod mount |
| 31 | AEL (exposure lock) button..... 87, 251 | 41 | Vari-angle LCD monitor..... 9, 12, 14
Touch screen..... 21, 135, 227 |
| 32 | AFON button..... 87, 251 | 42 | Eye sensor..... 15 |
| 33 | Strap clip..... 28 | 43 | Memory card slot..... 30 |
| 34 | Indicator lamp..... 8, 162
Tally light..... 162 | 44 | Battery chamber..... 30 |
| 35 | Focus stick (focus lever)..... 5, 76, 222 | 45 | Battery latch..... 31 |
| | | 46 | Serial number plate..... see below |

- 22** Use of an optional RR-100 remote release requires a third-party adapter to convert the three-pin, $\varnothing 2.5$ mm connector to a three-pin, $\varnothing 3.5$ mm connector.
- 46** Do not remove the serial number plate, which provides the CMIIT ID, serial number, and other important information.

Camera Functions

The Mode Dial

To select a shooting mode, rotate the dial until the icon for the desired mode aligns with the index.

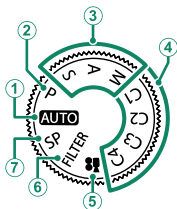

Mode	Description	
① AUTO (AUTO)	The camera automatically optimizes settings to the scene.	42
② P (PROGRAM AE)	Aperture and shutter speed can be adjusted using program shift.	57
③ S (SHUTTER PRIORITY AE) A (APERTURE PRIORITY AE) M (MANUAL)	Select for full control over camera settings, including aperture (M and A) and/or shutter speed (M and S).	58 60 62
④ C1/C2/C3/C4 (CUSTOM 1/2/3/4)	Take pictures using previously-stored settings.	67
⑤  (MOVIE)	Record movies.	48
⑥ FILTER (FILTER)	Take photos with filter effects.	66
⑦ SP (SCENE POSITION)	Choose a scene suited to the subject or shooting conditions and let the camera do the rest.	64

The Focus Stick (Focus Lever)

Tilt or press the focus stick to select the focus area. The focus stick can also be used to navigate the menus.

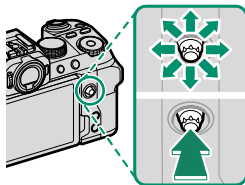







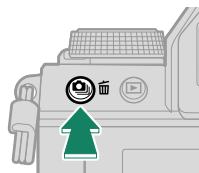

Use  **BUTTON/DIAL SETTING** > **FOCUS LEVER SETTING** to choose the role played by the focus stick (📖 222).

(Drive) Button

Pressing the  (drive) button displays drive-mode menu, where you can choose from the following the drive modes.



Mode			Mode		
	Single frame	56	BKT	Bracketing	90
	High-speed burst	93		HDR	94
	Low-speed burst	93		Panorama	96
	ISO BKT	89		Multiple Exposure	99
	WHITE BALANCE BKT	89			

The Command Dials

The rear and front command dials are used for the operations below.



	Front command dial	Rear command dial
Shooting	<ul style="list-style-type: none">• Choose the desired combination of shutter speed and aperture (program shift).• Adjust aperture.• Choose a shutter speed.• Choose a scene.	<ul style="list-style-type: none">• Adjust exposure compensation.• Choose a shutter speed.
Menus	Select menu tabs or page through menus.	Highlight menu items.
Q Menu	Select items in the quick menu.	Adjust settings in the quick menu.
Playback	View other pictures.	<ul style="list-style-type: none">• Zoom in or out (full-frame playback).• Zoom in or out (multi-frame playback).

 For information on the roles performed by the dials during shooting, see “The Command and Function Dials” (📖 69).

The Fn (Function) Dial

Rotate the function dial to quickly adjust settings for the assigned function during shooting.

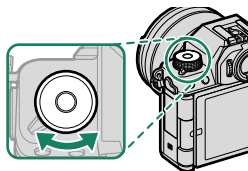

At shipment, the dial is assigned the **DEFAULT** role. At this setting, the function performed by the dial varies with the position of the mode dial.

Mode	Description
FILTER (FILTER)	Filter selection
P (PROGRAM AE)	Film simulation
S (SHUTTER PRIORITY AE)	
A (APERTURE PRIORITY AE)	
M (MANUAL)	
AUTO (AUTO)	
SP (SCENE POSITION)	
MOVIE (MOVIE)	
C1/C2/C3/C4 (CUSTOM)	

 The role performed by the function dial can be chosen using **▶ BUTTON/DIAL SETTING > FUNCTION (Fn) SETTING** (📖 254).

The Indicator Lamp

Camera status is shown by the indicator lamp.

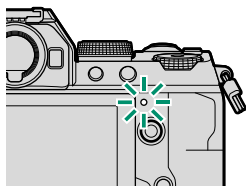

Indicator lamp	Camera status
Glows green	Focus locked.
Blinks green	Focus or slow shutter speed warning. Pictures can be taken.
Blinks green and orange	<ul style="list-style-type: none">• Camera on: Recording pictures. Additional pictures can be taken.• Camera off: Uploading pictures to a smartphone or tablet.*
Glows orange	Recording pictures. No additional pictures can be taken at this time.
Blinks orange	Flash charging; flash will not fire when picture is taken.
Blinks red	Lens or memory error.

* Displayed only if pictures are selected for upload.



- Warnings may also appear in the display.
- The indicator lamp remains off while your eye is to the viewfinder.
- The **MOVIE SETTING > TALLY LIGHT** option can be used to choose the lamp (indicator or AF-assist) that lights during movie recording and whether the lamp blinks or remains steady.

The LCD Monitor

You can adjust the angle of the LCD monitor when framing shots, but be careful not to trap your fingers or other objects.

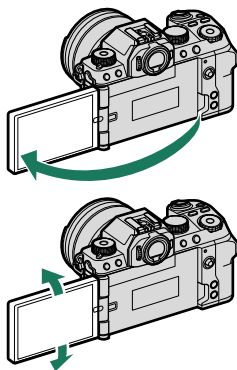

- ⚠ Do not apply excessive force to the hinge when rotating the LCD monitor, as this could damage the hinge.
- Be careful that the corners of the monitor do not contact the camera body, as this could leave marks.

📱 The LCD monitor also functions as a touch screen that can be used for:

- Touch photography (📖 22)
- Focus area selection (📖 21)
- Function selection (📖 24)
- Movie optimized control 🎞 (📖 23)
- Full-frame playback operations (📖 25)

Focusing the Viewfinder

If the indicators displayed in the viewfinder are blurred, put your eye to the viewfinder and rotate the diopter adjustment control until the display is in sharp focus.

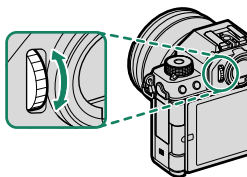

Camera Displays

This section lists the indicators that may be displayed during shooting.

! For illustrative purposes, displays are shown with all indicators lit.

The Electronic Viewfinder

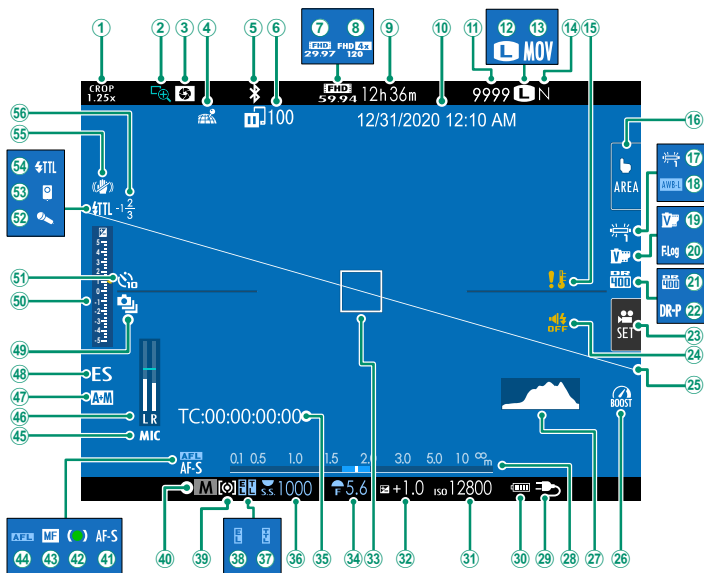

① Crop factor.....	138	②⑨ Power supply.....	34
② Focus check.....	80, 132	③⑩ Battery level.....	36
③ Depth-of-field preview.....	61, 80	④⑪ Sensitivity.....	83
④ Location data download status.....	239, 278	⑤⑫ Exposure compensation.....	82
⑤ Bluetooth ON/OFF.....	234	⑥⑬ Focus frame.....	75, 86
⑥ Image transfer status.....	234, 278	⑦⑭ Aperture.....	57, 60, 62
⑦ Movie mode.....	48, 154	⑧⑮ Time code.....	177
⑧ Full HD high-speed recording.....	156	⑨⑯ Shutter speed.....	57, 58, 62
⑨ Recording time available/ elapsed recording time.....	48	⑩⑰ TTL lock.....	149, 253
⑩ Date and time.....	37, 39, 207	⑪⑱ AE lock.....	87, 226
⑪ Number of available frames ¹	321	⑫⑲ Metering.....	85
⑫ Image size.....	106	⑬⑳ Shooting mode.....	56
⑬ File format.....	155	⑭㉑ Focus mode ²	71
⑭ Image quality.....	107	⑮㉒ Focus indicator ²	72
⑮ Temperature warning.....	320	⑯㉓ Manual focus indicator ²	71, 79
⑯ Touch screen mode.....	21, 135	⑰㉔ AF lock.....	87, 226
⑰ White balance.....	111	⑱㉕ Mic jack setting.....	175
⑱ AWB lock.....	226	㉒㉖ Recording level ²	174
⑲ Film simulation.....	108	㉓㉗ AF+MF indicator ²	131
⑲ F-Log recording.....	157	㉔㉘ Shutter type.....	144
⑲ Dynamic range.....	115	㉕㉙ Continuous mode.....	93
⑲ D-range priority.....	116	㉖㉚ Exposure indicator.....	62
⑲ Movie optimized control.....	23	㉗㉛ Self-timer indicator.....	139
⑲ Sound and flash indicator.....	209	㉘㉜ Microphone.....	50
⑲ Virtual horizon.....	18	㉙㉝ Remote release.....	59
⑲ Boost mode.....	230	㉚㉞ Flash (TTL) mode.....	267
⑲ Histogram.....	18	㉛㉟ IS mode ²	146
⑲ Distance indicator ²	80	㉜㉞ Flash compensation.....	267

1 Shows "9999" if there is space for over 9999 frames.

2 Not displayed when **ON** is selected for **SCREEN SET-UP > LARGE INDICATORS MODE(EVF)**.

The LCD Monitor

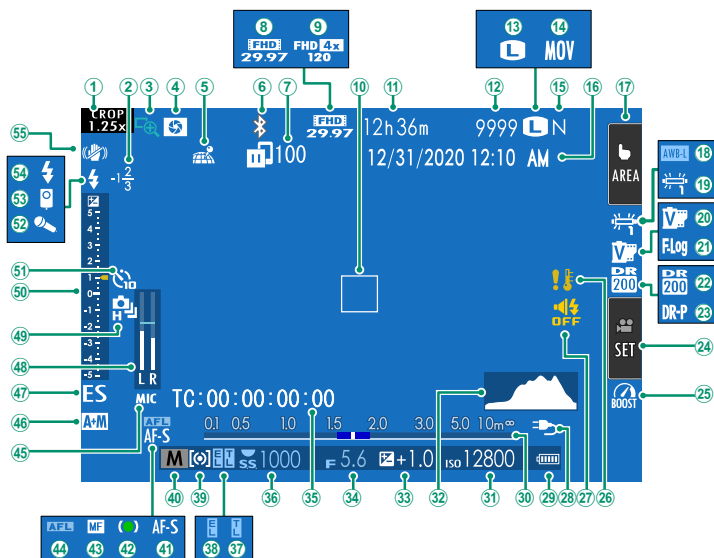

① Crop factor.....	138	②⑧ Power supply.....	34
② Flash compensation.....	267	②⑨ Battery level.....	36
③ Focus check.....	80, 132	③⑩ Distance indicator ²	80
④ Depth-of-field preview.....	61, 80	③① Sensitivity.....	83
⑤ Location data download status.....	239, 278	③② Histogram.....	18
⑥ Bluetooth ON/OFF.....	234	③③ Exposure compensation.....	82
⑦ Image transfer status.....	234, 278	③④ Aperture.....	57, 60, 62
⑧ Movie mode.....	48, 154	③⑤ Time code.....	177
⑨ Full HD high-speed recording.....	156	③⑥ Shutter speed.....	57, 58, 62
⑩ Focus frame.....	75, 86	③⑦ TTL lock.....	149, 253
⑪ Recording time available/ elapsed recording time.....	48	③⑧ AE lock.....	87, 226
⑫ Number of available frames ¹	321	③⑨ Metering.....	85
⑬ Image size.....	106	④⑩ Shooting mode.....	56
⑭ File format.....	155	④① Focus mode ²	71
⑮ Image quality.....	107	④② Focus indicator ²	72
⑯ Date and time.....	37, 39, 207	④③ Manual focus indicator ²	71, 79
⑰ Touch screen mode.....	21, 135	④④ AF lock.....	87, 226
⑱ AWB lock.....	226	④⑤ Mic jack setting.....	175
⑲ White balance.....	111	④⑥ AF+MF indicator ²	131
⑳ Film simulation.....	108	④⑦ Shutter type.....	144
㉑ F-Log recording.....	157	④⑧ Recording level ²	174
㉒ Dynamic range.....	115	④⑨ Continuous mode.....	93
㉓ D-range priority.....	116	⑤⑩ Exposure indicator.....	62
㉔ Movie optimized control.....	23	⑤① Self-timer indicator.....	139
㉕ Boost mode.....	230	⑤② Microphone.....	50
㉖ Temperature warning.....	320	⑤③ Remote release.....	59
㉗ Sound and flash indicator.....	209	⑤④ Flash (TTL) mode.....	267
		⑤⑤ IS mode ²	146

1 Shows "9999" if there is space for over 9999 frames.

2 Not displayed when **ON** is selected for **SCREEN SET-UP > LARGE INDICATORS MODE(LCD)**.

Adjusting Display Brightness

The brightness and hue of the viewfinder and LCD monitor can be adjusted using the items in the  **SCREEN SET-UP** menu. Choose **EVF BRIGHTNESS** or **EVF COLOR** to adjust viewfinder brightness or hue, **LCD BRIGHTNESS** or **LCD COLOR** to do the same for the LCD monitor.







Display Rotation

When **ON** is selected for  **SCREEN SET-UP** > **AUTOROTATE DISPLAYS**, the indicators in the viewfinder and LCD monitor automatically rotate to match camera orientation.



Choosing a Display Mode

Use  **SCREEN SET-UP** > **VIEW MODE SETTING** to choose from the following display modes. You can choose separate display modes for shooting and playback.

SHOOTING

Option	Description
 EYE SENSOR	Putting your eye to the viewfinder turns the viewfinder on and the LCD monitor off; taking your eye away turns the viewfinder off and LCD monitor on.
 EVF ONLY	Viewfinder on, LCD monitor off.
 LCD ONLY	LCD monitor on, viewfinder off.
 EVF ONLY + 	Putting your eye to the viewfinder turns the viewfinder on; taking it away turns the viewfinder off. The LCD monitor remains off.
 +  EYE SENSOR + LCD IMAGE DISP.	Putting your eye to the viewfinder during shooting turns the viewfinder on, but the LCD monitor is used for the display of images once you remove your eye from the viewfinder after shooting.

PLAYBACK

Option	Description
 EYE SENSOR	Putting your eye to the viewfinder turns the viewfinder on and the LCD monitor off; taking your eye away turns the viewfinder off and LCD monitor on.
 EVF ONLY	Viewfinder on, LCD monitor off.
 LCD ONLY	LCD monitor on, viewfinder off.

The Eye Sensor

The eye sensor may respond to objects other than your eye or to light shining directly on the sensor.

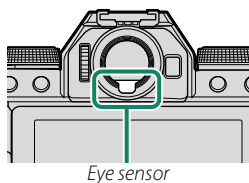

The DISP/BACK Button

The **DISP/BACK** button controls the display of indicators in the viewfinder and LCD monitor.

 Indicators for the EVF and LCD must be selected separately. To choose the EVF display, place your eye to the viewfinder while using the **DISP/BACK** button.

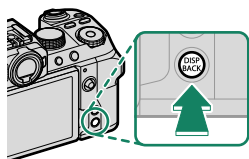

Viewfinder (EVF)

Standard indicators



*Full screen
(no indicators)*



LCD Monitor

Standard indicators

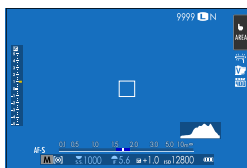

No indicators



Info display (still photography only)

Customizing the Standard Display

To choose the items shown in the standard indicator display:

- 1 Display standard indicators.**
Use the **DISP/BACK** button to display standard indicators.
- 2 Select DISP. CUSTOM SETTING.**
Select **SCREEN SET-UP > DISP. CUSTOM SETTING** in the setup menu.
- 3 Choose items.**
Highlight items and press **MENU/OK** to select or deselect.

Item	Default	Item	Default
FRAMING GUIDELINE	<input type="checkbox"/>	CONTINUOUS MODE	<input checked="" type="checkbox"/>
ELECTRONIC LEVEL	<input type="checkbox"/>	DUAL IS MODE	<input checked="" type="checkbox"/>
FOCUS FRAME	<input checked="" type="checkbox"/>	TOUCH SCREEN MODE	<input checked="" type="checkbox"/>
AF DISTANCE INDICATOR	<input type="checkbox"/>	WHITE BALANCE	<input checked="" type="checkbox"/>
MF DISTANCE INDICATOR	<input checked="" type="checkbox"/>	FILM SIMULATION	<input checked="" type="checkbox"/>
HISTOGRAM	<input type="checkbox"/>	DYNAMIC RANGE	<input checked="" type="checkbox"/>
LIVE VIEW HIGHLIGHT ALERT	<input type="checkbox"/>	BOOST MODE	<input checked="" type="checkbox"/>
SHOOTING MODE	<input checked="" type="checkbox"/>	FRAMES REMAINING	<input checked="" type="checkbox"/>
APERTURE/S-SPEED/ISO	<input checked="" type="checkbox"/>	IMAGE SIZE/QUALITY	<input checked="" type="checkbox"/>
INFORMATION BACKGROUND	<input checked="" type="checkbox"/>	MOVIE MODE & REC. TIME	<input checked="" type="checkbox"/>
Expo. Comp. (Digit)	<input type="checkbox"/>	IMAGE TRANSFER ORDER	<input checked="" type="checkbox"/>
Expo. Comp. (Scale)	<input checked="" type="checkbox"/>	MIC LEVEL	<input checked="" type="checkbox"/>
FOCUS MODE	<input checked="" type="checkbox"/>	GUIDANCE MESSAGE	<input checked="" type="checkbox"/>
PHOTOMETRY	<input checked="" type="checkbox"/>	BATTERY LEVEL	<input checked="" type="checkbox"/>
SHUTTER TYPE	<input checked="" type="checkbox"/>	FRAMING OUTLINE	<input type="checkbox"/>
FLASH	<input checked="" type="checkbox"/>		

- 4 Press DISP/BACK to save changes.**
- 5 Press DISP/BACK as needed to exit the menus and return to the shooting display.**

Virtual Horizon

Selecting **ELECTRONIC LEVEL** displays a virtual horizon. The camera is level when the two lines overlap. Note that the virtual horizon may not be displayed if the camera lens is pointed up or down. For a 3D display (shown), press the function button to which **ELECTRONIC LEVEL** is assigned (📖 251).

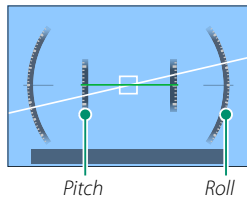

Framing Outline

Enable **FRAMING OUTLINE** to make the borders of the frame easier to see against dark backgrounds.

Histograms

Histograms show the distribution of tones in the image. Brightness is shown by the horizontal axis, the number of pixels by the vertical axis.

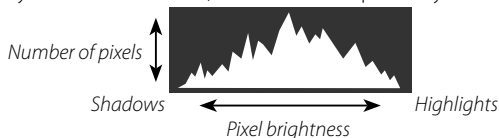

- **Optimal exposure:** Pixels are distributed in an even curve throughout the tone range.
- **Overexposed:** Pixels are clustered on the right side of the graph.
- **Underexposed:** Pixels are clustered on the left side of the graph.

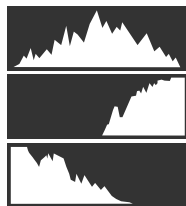

To view separate RGB histograms and a display showing areas of the frame that will be overexposed at current settings superimposed on the view through the lens, press the function button to which **HISTOGRAM** is assigned (📖 251).

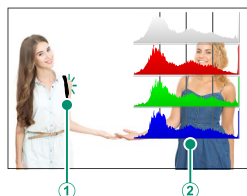

- ① *Overexposed areas blink*
- ② *RGB histograms*

Using the Menu

To display the menus, press **MENU/OK**.

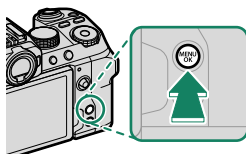

The Menu

Different menus are displayed during still photography, movie recording, and playback.

Shooting

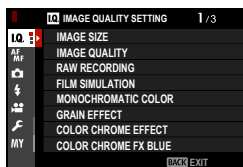
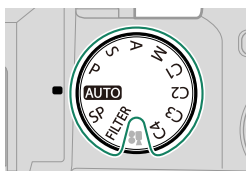

Still photography: Mode dial rotated to position other than  (movie)

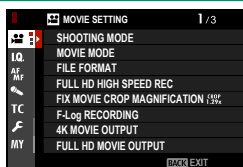
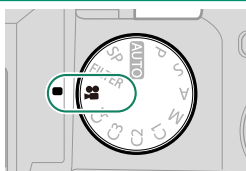

Movie recording: Mode dial rotated to  (movie)

Playback

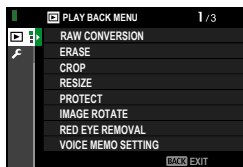
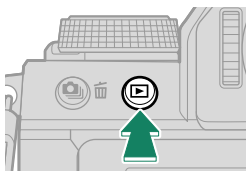

During playback

Selecting a Menu Tab

To navigate the menus:

- 1 Press **MENU/OK** to display the menus.

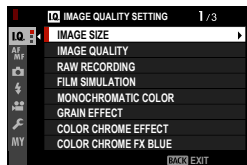
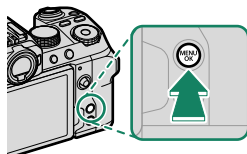

- 2 Press the focus stick (focus lever) left to highlight the tab for the current menu.

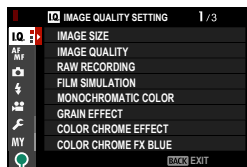

Tab

- 3 Press the focus stick up or down to highlight the tab containing the desired item.
- 4 Press the focus stick right to place the cursor in the menu.

 Use the front command dial to select menu tabs or page through menus and the rear command dial to highlight menu items.

Touch Screen Mode

The LCD monitor also functions as a touch screen.

Shooting Touch Controls

To enable touch controls, select **ON** for **☑️ BUTTON/DIAL SETTING > TOUCH SCREEN SETTING > 📷 TOUCH SCREEN SETTING**.

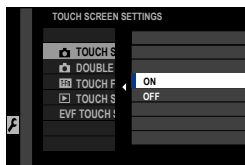

EVF

The LCD monitor can be used to select the focus area while pictures are being framed in the electronic viewfinder (EVF). Use **☑️ BUTTON/DIAL SETTING > TOUCH SCREEN SETTING > EVF TOUCH SCREEN AREA SETTINGS** to choose the area of the monitor employed for touch controls.

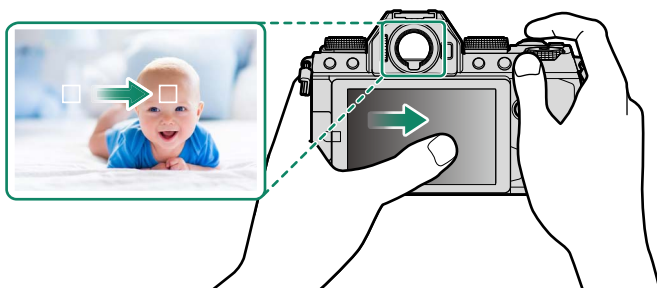





📷 When **FACE DETECTION ON** is selected for **📷 AF/MF SETTING > FACE/EYE DETECTION SETTING**, you can choose the face used for focus.

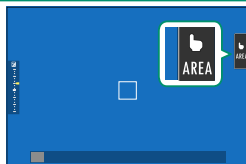

LCD Monitor

The operation performed can be selected by tapping the touch screen mode indicator in the display. Touch controls can be used for the following operations:



Mode	Description
 TOUCH SHOOTING	Tap your subject in the display to focus and release the shutter. In burst mode, pictures will be taken while you keep your finger on the display.
 AF ↓ ↑  AF OFF	<ul style="list-style-type: none">• If SINGLE AF is selected for focus mode, the camera will focus when you tap your subject in the display. Focus locks at the current distance until you tap the AF OFF icon.• If CONTINUOUS AF is selected for focus mode, the camera will initiate focus when you tap your subject in the display. The camera will continue to adjust focus for changes in the distance to the subject until you tap the AF OFF icon.• When MANUAL FOCUS is selected for focus mode, you can tap the display to focus on the selected subject using autofocus.
 AREA	Tap to select a point for focus or zoom. The focus frame will move to the selected point.
 OFF	Touch controls disabled.

ⓘ Different touch controls are used during focus zoom (📖 136).





- To disable touch controls and hide the touch screen mode indicator, select **OFF** for  **BUTTON/DIAL SETTING > TOUCH SCREEN SETTING > TOUCH SCREEN SETTING**.
- Touch control settings can be adjusted using  **AF/MF SETTING > TOUCH SCREEN MODE**. For information on the touch controls available during movie recording, see “Movie Recording ( **TOUCH SCREEN MODE**; 📖 171)”.

MOVIE OPTIMIZED CONTROL

Selecting **ON** for **MOVIE SETTING > MOVIE OPTIMIZED CONTROL ** or tapping the movie-optimized mode button in the shooting display optimizes the command dials and touch controls for movie recording. This can be used to prevent camera sounds being recorded with movie footage.



Movie-optimized mode button

- SHUTTER SPEED
- APERTURE
- EXPOSURE COMPENSATION
- ISO
- INTERNAL MIC LEVEL ADJUSTMENT/EXTERNAL MIC LEVEL ADJUSTMENT
- WIND FILTER
- HEADPHONES VOLUME
-  FILM SIMULATION
-  WHITE BALANCE
-  IS MODE
-  IS MODE BOOST
-  FOCUS MODE





- Enabling movie-optimized controls disables the aperture ring.
- When movie-optimized control is enabled, the movie-optimized mode button can be used to change shooting settings or disable movie-optimized control.

Touch Function

Functions can be assigned to the following flick gestures in much the same way as function buttons (📖 255):

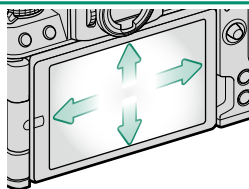
- Flick up: **T-Fn1**
- Flick left: **T-Fn2**
- Flick right: **T-Fn3**
- Flick down: **T-Fn4**



- In some cases, touch-function flick gestures display a menu; tap to select the desired option.
- Touch-function gestures are disabled by default. To enable touch-function gestures, select **ON** for **🔘 BUTTON/DIAL SETTING > TOUCH SCREEN SETTING >  TOUCH FUNCTION.**

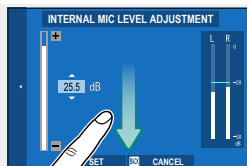

Playback Touch Controls

When **ON** is selected for **▶️ BUTTON/DIAL SETTING > TOUCH SCREEN SETTING > ▶️ TOUCH SCREEN SETTING**, touch controls can be used for the following playback operations:

- **Swipe:** Swipe a finger across the display to view other images.



- **Pinch-out:** Place two fingers on the display and spread them apart to zoom in.



- **Pinch-in:** Place two fingers on the display and slide them together to zoom out.



Pictures can be zoomed out until the entire image is visible but no further.

- **Double-tap:** Tap the display twice to zoom in on the focus point.



- **Drag:** View other areas of the image during playback zoom.

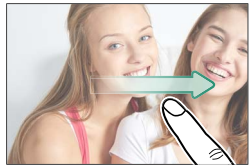

First Steps

2

Attaching the Strap

Attach the strap.

Attach the strap to the two strap clips as shown below.

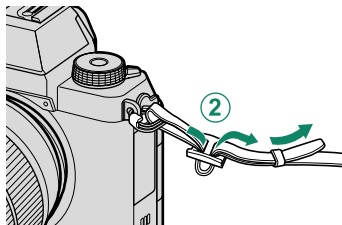
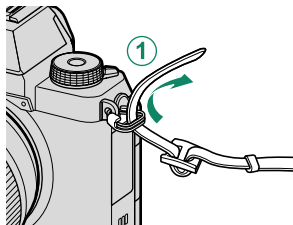

! To avoid dropping the camera, be sure the strap is correctly secured.

Attaching a Lens

The camera can be used with lenses for the FUJIFILM X-mount.

Remove the body cap from the camera and the rear cap from the lens. Place the lens on mount, keeping the marks on the lens and camera aligned (①), and then rotate the lens until it clicks into place (②).

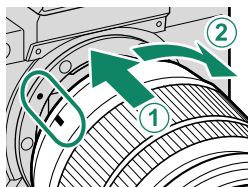

- ⓘ When attaching lenses, ensure that dust or other foreign matter does not enter the camera.
- Be careful not to touch the camera's internal parts.
- Rotate the lens until it clicks securely into place.
- Do not press the lens release button while attaching the lens.

Removing Lenses

To remove the lens, turn the camera off, then press the lens release button (①) and rotate the lens as shown (②).

- ⓘ To prevent dust accumulating on the lens or inside the camera, replace the lens caps and camera body cap when the lens is not attached.

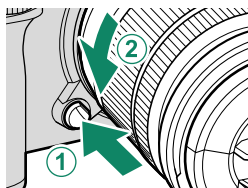

Lenses and Other Optional Accessories

The camera can be used with lenses and accessories for the FUJIFILM X-mount.

- ⓘ Observe the following precautions when attaching or removing (exchanging) lenses.
- Check that the lenses are free of dust and other foreign matter.
- Do not change lenses in direct sunlight or under another bright light source. Light focused into the interior of the camera could cause it to malfunction.
- Attach the lens caps before exchanging lenses.

Inserting the Battery and a Memory Card

Insert the battery and memory card as described below.

- 1 Slide the battery-chamber cover latch as shown and open the battery-chamber cover.

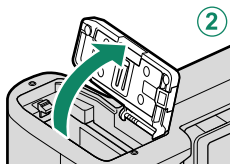
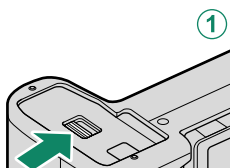

- 2 Insert the battery.

Using the battery to keep the battery latch pressed to one side, insert the battery contacts first in the direction shown by the arrow.

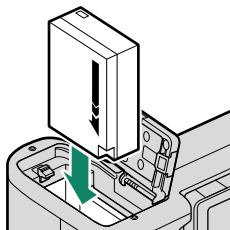

- 3 Insert the memory card.

 The optional SD, SDHC, and SDXC memory cards the camera uses to store pictures are referred to as "memory cards".

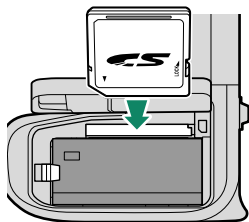



- 4 Close the battery-chamber cover and slide the battery-chamber cover latch closed.

Removing the Battery

Before removing the battery or memory card, *turn the camera off* and open the battery-chamber cover.

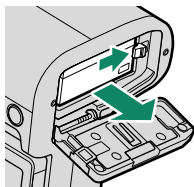
To remove the battery, press the battery latch to the side, and slide the battery out of the camera as shown.



 The battery may become hot when used in high-temperature environments. Observe caution when removing the battery.

Removing Memory Cards

To remove the memory card, press it in and release it slowly. The card can then be removed by hand.

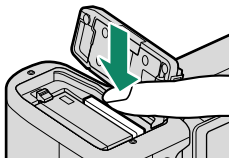

 • Press the center of the card when ejecting it.
• When a memory card is removed, the card could be ejected too quickly. Use your finger to hold it and gently release the card.

Compatible Memory Cards

- The camera can be used with SD, SDHC, and SDXC memory cards.
- The camera supports UHS-I memory cards.
- To record movies, use cards with a UHS speed class of 3 or better or a video speed class of V30 or better.
- A list of supported memory cards is available on the Fujifilm website. For details, visit:
<https://fujifilm-x.com/support/compatibility/cameras/>.

- !** • Do not turn the camera off or remove the memory card while the memory card is being formatted or data are being recorded to or deleted from the card. Failure to observe this precaution could damage the card.
- Memory cards can be locked, making it impossible to format the card or to record or delete images. Before inserting a memory card, slide the write-protect switch to the unlocked position. 
 - Memory cards are small and can be swallowed; keep out of reach of children. If a child swallows a memory card, seek medical assistance immediately.
 - miniSD or microSD adapters that are larger or smaller than memory cards may not eject normally; if the card does not eject, take the camera to an authorized service representative. Do not forcibly remove the card.
 - Do not affix labels or other objects to memory cards. Peeling labels can cause camera malfunction.
 - Movie recording may be interrupted with some types of memory card.
 - Formatting a memory card in the camera creates a folder in which pictures are stored. Do not rename or delete this folder or use a computer or other device to edit, delete, or rename image files. Always use the camera to delete pictures; before editing or renaming files, copy them to a computer and edit or rename the copies, not the originals. Renaming the files on the camera can cause problems during playback.

Charging the Battery

The battery is not charged at shipment. Charge the battery before use.

- ! An NP-W126S rechargeable battery is supplied with the camera.
 - Turn the camera off for charging.
- The camera can be charged via USB. USB charging is available with computers with a manufacturer-approved operating system and USB interface.

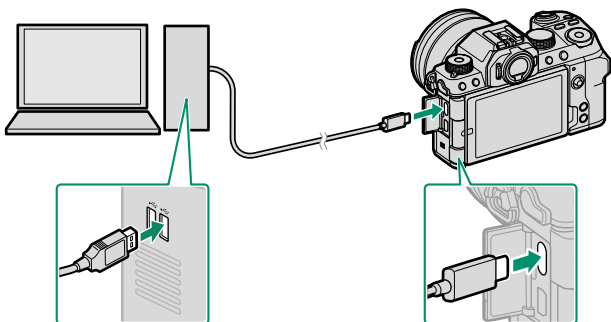

Leave the computer on during charging.

- ! The battery will not charge while the camera is on.
 - Connect the supplied USB cable.
 - Connect the camera directly to the computer; do not use a USB hub or keyboard.
 - Charging stops if the computer enters sleep mode. To resume charging, activate the computer and disconnect and reconnect the USB cable.
 - Charging may not be supported depending on the model of computer, computer settings, and the computer's current state.
 - The battery takes about 5 hours to charge with a charging input of 5 V/500 mA.
- To charge the battery from a household AC power outlet, use a BC-W126S battery charger (available separately).

Charge Status

The indicator lamp shows battery charge status as follows:



Indicator lamp	Battery status
On	Battery charging.
Off	Charging complete.
Blinks	Charging error.

2

First Steps

- ❗ • Do not affix labels or other objects to the battery. Failure to observe this precaution could make it impossible to remove the battery from the camera.
- Do not short the battery terminals. The battery could overheat.
- Read the cautions in “The Battery and Power Supply”.
- Use only genuine Fujifilm rechargeable batteries designated for use in this camera. Failure to observe this precaution could result in product malfunction.
- Do not remove the labels from the battery or attempt to split or peel the outer casing.
- The battery gradually loses its charge when not in use. Charge the battery one or two days before use.
- If the battery fails to hold a charge, it has reached the end of its charging life and must be replaced.
- Remove dirt from the battery terminals with a clean, dry cloth. Failure to observe this precaution could prevent the battery from charging.
- Note that charging times increase at low or high temperatures.

- 🔌 • If the camera is turned on during charging, charging will end and the USB connection will instead be used to power the camera. The battery level will begin to gradually decline (📖 238).
- The camera will display a “power supply” icon when powered via USB.

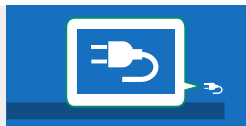

Turning the Camera On and Off

Use the **ON/OFF** switch to turn the camera on and off.

Slide the switch to **ON** to turn the camera on, or to **OFF** to turn the camera off.

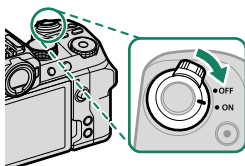

! Fingerprints and other marks on the lens or viewfinder can affect pictures or the view through the viewfinder. Keep the lens and viewfinder clean.





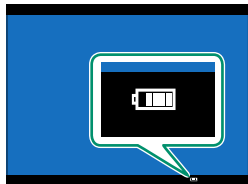

- 📄** Pressing the **▶** button during shooting starts playback.
- Press the shutter button halfway to return to shooting mode.
- The camera will turn off automatically if no operations are performed for the length of time selected for **▶ POWER MANAGEMENT > AUTO POWER OFF**. To reactivate the camera after it has turned off automatically, press the shutter button halfway or turn the **ON/OFF** switch to **OFF** and then back to **ON**.

Checking the Battery Level

After turning the camera on, check the battery level in the display.

Battery level is shown as follows:



Indicator	Description
	Battery partially discharged.
	Battery about 80% full.
	Battery about 60% full.
	Battery about 40% full.
	Battery about 20% full.
 (red)	Low battery. Charge as soon as possible.
 (blinks red)	Battery exhausted. Turn camera off and recharge battery.

Basic Setup

When you turn the camera on for the first time, you can choose a language and set the camera clock. At default settings, you can also pair the camera with a smartphone or tablet so that you can later synchronize the clocks or download pictures. Follow the steps below when turning the camera on for the first time.

 If you intend to pair the camera with a smartphone or tablet, install and launch the latest version of the FUJIFILM Camera Remote App on the smart device before proceeding. For more information, visit: http://app.fujifilm-dsc.com/en/camera_remote/

1 Turn the camera on.

A language-selection dialog will be displayed.

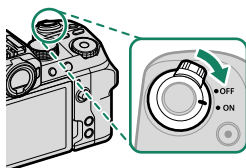

2 Choose a language.

Highlight a language and press **MENU/OK**.

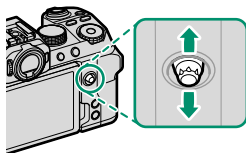

3 Pair the camera with the smartphone or tablet.

Press **MENU/OK** to pair the camera with a smartphone or tablet running the FUJIFILM Camera Remote app.

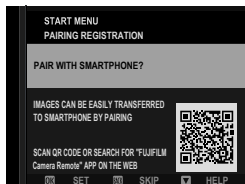

 To skip pairing, press **DISP/BACK**.

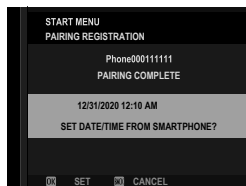

4 Check the time.

When pairing is complete, you will be prompted to set the camera clock to the time reported by the smartphone or tablet. Check that the time is correct.



 To set the clock manually, press **DISP/BACK** ( 39).

5 Synchronize the camera settings with the settings configured on your smartphone or tablet.

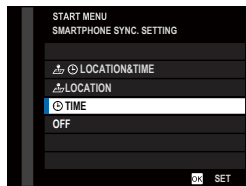



 The option selected can be changed at any time using **CONNECTION SETTING > Bluetooth SETTINGS**.

6 Set the clock.

Press **MENU/OK** to set the camera clock to the time reported by the smartphone or tablet and exit to shooting mode.

7 Format the memory card (206).

 Format memory cards before first use, and be sure to reformat all memory cards after using them in a computer or other device.

 If the battery is removed for an extended period, the camera clock will be reset and the language-selection dialog will be displayed when the camera is turned on.

Skipping the Current Step

If you skip a step, a confirmation dialog will be displayed; select **NO** to avoid repeating any steps you skipped the next time the camera is turned on.

Choosing a Different Language

To change the language:

- 1 Display language options.**
Select **USER SETTING** > **言語/LANG.**
- 2 Choose a language.**
Highlight the desired option and press **MENU/OK**.

Changing the Time and Date

To set the camera clock:

- 1 Display DATE/TIME options.**
Select **USER SETTING** > **DATE/TIME**.
- 2 Set the clock.**
Press the focus stick (focus lever) left or right to highlight the year, month, day, hour, or minute and press up or down to change. Press **MENU/OK** to set the clock.

Basic Photography and Playback

3

Taking Photographs

This section explains basic photography.

- 1 Rotate the mode dial to **AUTO** to view the **AUTO** shooting display.

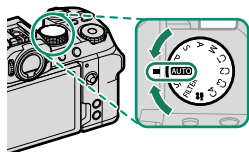

The camera automatically selects a scene according to the type of subject detected.

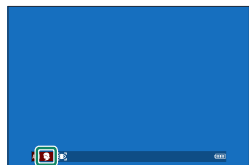

! In **AUTO (AUTO)** mode, the camera continuously adjusts focus and searches for eyes, increasing the drain on the battery; in addition, the sound of the camera focusing may be audible.

- 2 **Ready the camera.**

Hold the camera steady with both hands—shaking or unsteady hands can blur your shots.

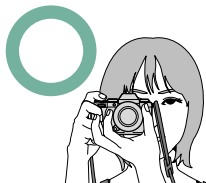

To prevent pictures that are out of focus or too dark (underexposed), keep your fingers and other objects away from the lens and AF-assist illuminator.

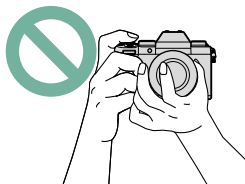

3 Frame the picture.

Lenses with Zoom Rings

Use the zoom ring to frame the picture in the display. Rotate the ring left to zoom out, right to zoom in.

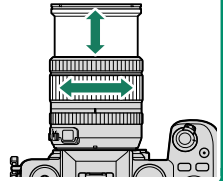

4 Focus.

Press the shutter button halfway to focus.

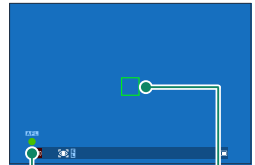

Focus indicator

Focus frame

- **If the camera is able to focus**, it will beep twice and focus frame and focus indicator will glow green.
- **If the camera is unable to focus**, the focus frame will turn red, **!AF** will be displayed, and the focus indicator will blink white.



- If the subject is poorly lit, the AF-assist illuminator may light to assist the focus operation.
- Focus and exposure will lock when the shutter button is pressed halfway. Focus and exposure remain locked while the button is kept in this position (AF/AE lock).
- The camera will focus on subjects at any distance in the macro and standard focus ranges for the lens.

5 Shoot.

Smoothly press the shutter button the rest of the way down to take the picture.

Viewing Pictures

Pictures can be viewed in the viewfinder or LCD monitor.

To view pictures full frame, press .

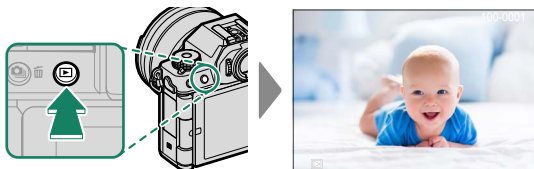



Press the focus stick (focus lever) left to page through pictures in reverse order. Press it right to page through pictures in the order recorded. Keep the stick pressed to scroll rapidly to the desired frame.

-  You can also page through pictures using the front command dial or swipe gestures.
- Pictures taken using other cameras are marked with a  (“gift image”) icon to warn that they may not display correctly and that playback zoom may not be available.

Deleting Pictures

Use the  (delete) button to delete pictures.

 Deleted pictures cannot be recovered. Protect important pictures or copy them to a computer or other storage device before proceeding.

- 1 With a picture displayed full frame, press the  button and select **FRAME**.

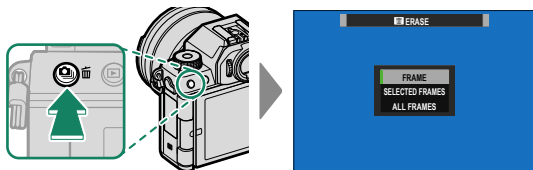

- 2 Choose a picture and press **MENU/OK** to delete it.
 - The picture will be deleted when the **MENU/OK** button is pressed; a confirmation dialog is not displayed. Be careful not to accidentally delete pictures you wish to keep.
 - Additional pictures can be deleted using the **MENU/OK** button. Display the desired pictures and press **MENU/OK** to delete them one by one.

 Protected pictures cannot be deleted. Remove protection from any pictures you wish to delete (📖 192).

- Pictures can also be deleted from the menus using the  **PLAY BACK MENU > ERASE** option (📖 188).



Movie Recording and Playback

4

Recording Movies

Record movies with sound.

Recording Movies

Movies can be recorded by pressing the  (movie recording) button or rotating the mode dial to  (movie).

The (Movie Recording) Button

Use the  (movie recording) button to quickly and easily record movies while in still photography mode.

 The camera automatically selects **CONTINUOUS AF** for focus mode.

1 Press  to start recording.

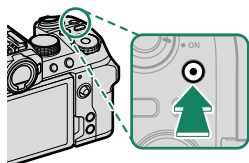

- A recording indicator () is displayed while recording is in progress.
- The display shows the elapsed recording time.

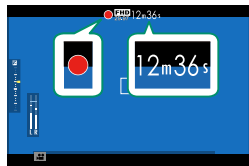

2 Press  again to end recording.
Recording ends automatically when the movie reaches 29 minutes 59 seconds or the memory card is full.

(Movie) Mode

For more control over camera settings, rotate the mode dial to  (movie) and record movies using the shutter button.

- 1 Rotate the mode dial to  (movie).

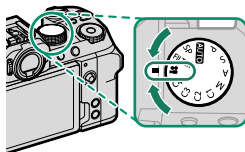

- 2 Press the shutter button to start recording.

- A recording indicator (●) is displayed while recording is in progress.
- The display shows the elapsed recording time.

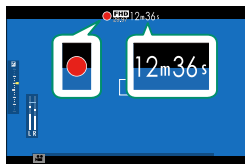

- 3 Press the shutter button again to end recording. Recording ends automatically when the movie reaches 29 minutes 59 seconds or the memory card is full.

Temperature Warnings

The camera automatically turns off to protect itself when its temperature or the temperature of the battery rises. If a temperature warning is displayed, image noise may increase. Turn the camera off and wait for it to cool before turning it on again (📖 320).

- ❗ Use a memory card with a UHS speed class of 3 or better when recording movies.
- Sound is recorded via the built-in microphone or an optional external microphone. Do not cover the microphone during recording.
- Note that the microphone may pick up lens noise and other sounds made by the camera during recording.
- Vertical or horizontal streaks may appear in movies containing very bright subjects. This is normal and does not indicate a malfunction.

- 📄 The indicator lamp lights while recording is in progress.
- In the case of zoom lenses, zoom can be adjusted during recording using the zoom ring (if available).
- Exposure compensation can be adjusted during recording, but only by a maximum of ± 2 EV.
- Recording may be unavailable at some settings, while in other cases settings may not apply during recording.
- Headphones connected via USB can be used to monitor audio during movie recording. Use the supplied headphone adapter to convert the USB connector to a plug for a headphone jack.



Using an External Microphone

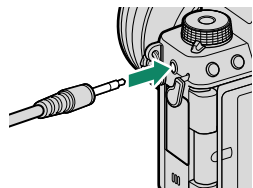

Sound can be recorded with external microphones that connect using jacks 3.5 mm in diameter; microphones that require plug-in power cannot be used. See the microphone manual for details.



Adjusting Movie Settings

Movie settings can be adjusted from the movie menus or using the  **MOVIE SETTING** item in the photo menus (📖 19).

- Use the  **MOVIE SETTING** item in the photo menus to quickly adjust settings when recording movies via the  (movie recording) button (📖 151).
- The movie menus contain options for use when recording movies via the shutter button in  (movie) mode (📖 154).

 Changes made using the  **MOVIE SETTING** item in the photo menus also apply to the movie menus. Changes made in one set of menus automatically apply in the other.

Depth of Field

To soften backgrounds, set aperture as wide as possible. Aperture can be adjusted directly in modes **A** (aperture-priority AE) and **M** (manual).

Viewing Movies

View movies on the camera.

In full-frame playback, movies are identified by a  icon. Press the focus stick (focus lever) down to start movie playback.

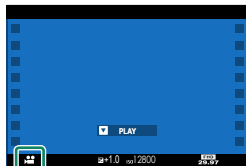

The following operations can be performed while a movie is displayed:

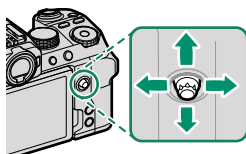

Focus stick (focus lever)	Full-frame playback	Playback in progress (▶)	Playback paused (⏸)
Up	—	End playback	
Down	Start playback	Pause playback	Start/resume playback
Left/right	View other pictures	Adjust speed	Single frame rewind/advance

Progress is shown in the display during playback.

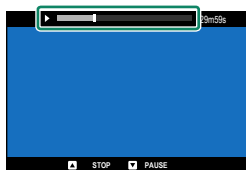

- Do not cover the speaker during playback.
- Sound is not played back if **OFF** is selected for **USER SETTING > SOUND & FLASH**.
- Press **MENU/OK** to pause playback and display volume controls. Press the focus stick (focus lever) up or down to adjust the volume; press **MENU/OK** again to resume playback. Volume can also be adjusted using **SOUND SET-UP > PLAYBACK VOLUME**.
- Audio can be played back over headphones or other devices connected via USB using the supplied headphone adapter.

Playback Speed

Press the focus stick (focus lever) left or right to adjust playback speed during playback. Speed is shown by the number of arrows (▶ or ◀).

*Arrows*

Taking Photographs

5

Choosing a Shooting Mode

Choose a shooting mode according to the scene or type of subject.

AUTO (AUTO)

When the mode dial is rotated to **AUTO**, the camera automatically optimizes settings to suit the scene.

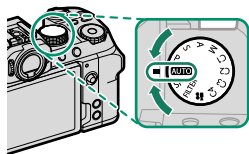

The display shows the icon for the mode most closely matching the type of scene detected by the camera.

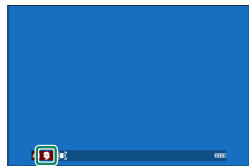

▲ : LANDSCAPE

☾ : NIGHT

☾ : NIGHT (TRIPOD)

🌸 : MACRO

🌅 : SUNSET

☀️ : SKY

🌲 : GREENERY

👤 : PORTRAIT

👤 : BACKLIT PORTRAIT

👤 : MOVING OBJECT

👤 : PORTRAIT&MOTION

👤 : BACKLIT PORTRAIT&MOTION

⚠️ • The mode selected may vary with shooting conditions. If the mode and subject do not match, select mode **P** or choose **SP** and select a scene manually.

- The additional processing time required in some scene modes may increase save times.

📄 No icon will be displayed if the camera is unable to determine the type of scene.

Program AE (P)

Let the camera choose shutter speed and aperture for optimal exposure. Other values that produce the same exposure can be selected with program shift.

Rotate the mode dial to P.

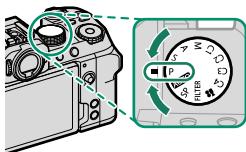

P will appear in the display.

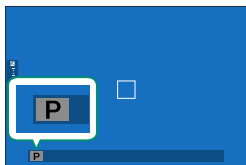

Program Shift

Rotate the front command dial to choose the desired combination of shutter speed and aperture (program shift).

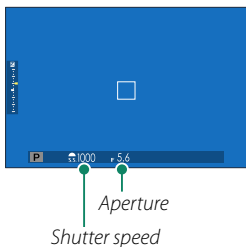

! Program shift is not available in any of the following circumstances:

- With flash units that support TTL auto
- When a flash mode other than **OFF** is selected for **FLASH SETTING > FLASH FUNCTION SETTING**
- When an auto option is selected for **IMAGE QUALITY SETTING > DYNAMIC RANGE**
- In movie mode

🔄 To cancel program shift, turn the camera off.

Shutter-Priority AE (S)

Choose a shutter speed and let the camera adjust aperture for optimal exposure.

- 1 Rotate the mode dial to S.

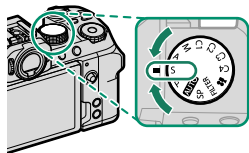

S will appear in the display.

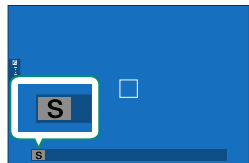

- 2 Use the front command dial to choose a shutter speed.

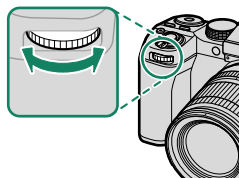

- ! If the correct exposure cannot be achieved at the selected shutter speed, aperture will be displayed in red.
- If the subject is outside the metering range of the camera, the aperture display will show “- - -”.

Time (T)

Shutter speeds of 1 s or slower are referred to as “long time-exposures”. Use of a tripod is recommended to prevent the camera moving during the exposure.

- A count-down timer will be displayed while the exposure is in progress.
- To reduce “noise” (mottling) in long time-exposures, select **ON** for **IMAGE QUALITY SETTING > LONG EXPOSURE NR.** Note that this may increase the time needed to record images after shooting.

Using a Remote Release

A remote release can be used for long time-exposures. When using an optional RR-100 remote release or an electronic release from third-party suppliers, connect it to the camera’s microphone/remote release connector via a third-party \varnothing 2.5 mm to 3.5 mm adapter.

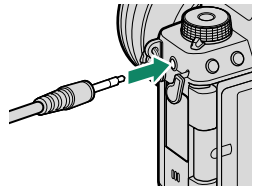

- A confirmation dialog will be displayed when a remote release is connected; press **MENU/OK** and select **REMOTE** for **MIC/REMOTE RELEASE**.

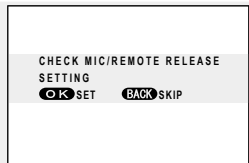

Aperture-Priority AE (A)

Choose an aperture and let the camera adjust shutter speed for optimal exposure.

- 1 Rotate the mode dial to A.

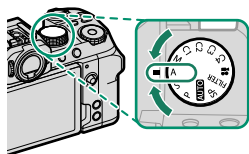

A will appear in the display.

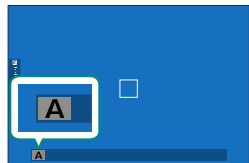

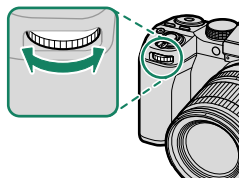

- 2 Use the front command dial to choose an aperture.



- ⚠ If the correct exposure cannot be achieved at the selected aperture, shutter speed will be displayed in red.
 - If the subject is outside the metering range of the camera, the shutter speed display will show "— —".
- 🔧 If the lens is equipped with a aperture ring, aperture can be adjusted by rotating the ring.

Previewing Depth of Field

When **PREVIEW DEPTH OF FIELD** is assigned to a function button, pressing the button displays a  icon and stops aperture down to the selected setting, allowing depth of field to be previewed in the display ( 251).

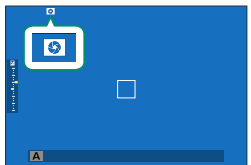

Manual Exposure (M)

Alter exposure from that selected by the camera.

- 1 Rotate the mode dial to M.

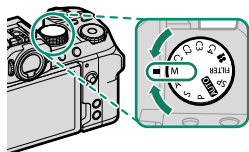

M will appear in the display.

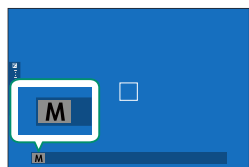

- 2 Rotate the rear command dial to choose a shutter speed and the front command dial to choose the aperture.

 The manual exposure display includes an exposure indicator that shows the amount the picture would be under- or over-exposed at current settings.

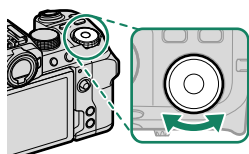

Shutter speed

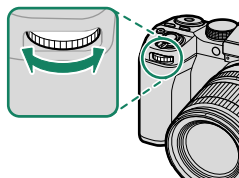

Aperture

 If the lens is equipped with an aperture ring, aperture can be adjusted by rotating the ring.

Bulb (B)

Choose a shutter speed of **BULB** for long time-exposures in which you open and close the shutter manually. Use of a tripod is recommended to prevent the camera moving during the exposure.

- 1 Using the rear command dial, choose a shutter speed of **BULB**.

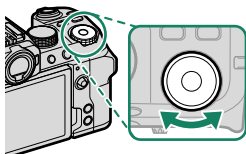

- 2 Press the shutter button all the way down. The shutter will remain open for up to 60 minutes while the shutter button is pressed; the display shows the time elapsed since the exposure started.

 To reduce “noise” (mottling) in long time-exposures, select **ON** for **IMAGE QUALITY SETTING > LONG EXPOSURE NR.** Note that this may increase the time needed to record images after shooting.

Exposure Preview

To preview exposure in the LCD monitor, select **PREVIEW EXP./WB** for **SCREEN SET-UP > PREVIEW EXP./WB IN MANUAL MODE.**



 Select an option other than **PREVIEW EXP./WB** when using the flash or on other occasions on which exposure may change when the picture is taken.

SP SCENE POSITION





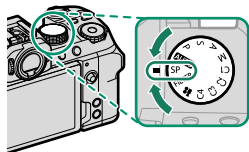









The camera offers a choice of “scenes”, each adapted to particular shooting conditions or a specific type of subject.

- 1 Rotate the mode dial to **SP (SCENE POSITION)**.



- 2 Choose a scene via **SHOOTING SETTING > SCENE POSITION**.

Choose from the following options:

Scene	Description
 PORTRAIT	Choose for portraits.
 PORTRAIT ENHANCER	Processes portraits to give the subject a smooth, natural-looking complexion.
 LANDSCAPE	Choose for daylight shots of buildings and landscapes.
 SPORT	Choose when photographing moving subjects.
 NIGHT	Choose for poorly lit twilight or night scenes.
 NIGHT (TRIPOD)	Choose this mode for slow shutter speeds when shooting at night.
 FIREWORKS	Slow shutter speeds are used to capture the expanding burst of light from a firework.
 SUNSET	Choose this mode to record the vivid colors in sunrises and sunsets.
 SNOW	Choose for crisp, clear shots that capture the brightness of scenes dominated by shining white snow.
 BEACH	Choose for crisp, clear shots that capture the brightness of sunlit beaches.
 UNDERWATER	Reduces the blue cast typically associated with underwater lighting.
 PARTY	Capture indoor background lighting under low-light conditions.
 FLOWER	Effective for taking more vivid shots of flowers.
 TEXT	Take clear pictures of text or drawings in print.

 The scene can also be selected in the shooting display via the front command dial.

FILTER

Take photos with filter effects.

- 1 Rotate the mode dial to **FILTER**.

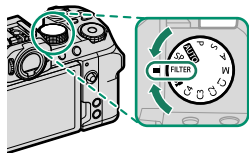

- 2 Choose a filter via **SHOOTING SETTING > FILTER SETTING**.

Filter	Description
TOY CAMERA	Choose for a retro toy camera effect.
MINIATURE	The tops and bottoms of pictures are blurred for a diorama effect.
POP COLOR	Create high-contrast images with saturated colors.
HIGH-KEY	Create bright, low-contrast images.
LOW-KEY	Create uniformly dark tones with few areas of emphasized highlights.
DYNAMIC TONE	Dynamic tone expression is used for a fantasy effect.
SOFT FOCUS	Create a look that is evenly soft throughout the whole image.
PARTIAL COLOR (RED)	Areas of the image that are the selected color are recorded in that color. All other areas of the image are recorded in black-and-white.
PARTIAL COLOR (ORANGE)	
PARTIAL COLOR (YELLOW)	
PARTIAL COLOR (GREEN)	
PARTIAL COLOR (BLUE)	
PARTIAL COLOR (PURPLE)	

Depending on the subject and camera settings, images may in some cases be grainy or vary in brightness or hue.

The scene can also be selected in the shooting display via the function dial.

Custom Modes

Rotate the mode dial to any of modes **C1 (CUSTOM 1)** through **C4 (CUSTOM 4)** to take pictures using previously-saved shooting menu settings. Settings can be saved or edited using **IMAGE QUALITY SETTING > EDIT/SAVE CUSTOM SETTING**.

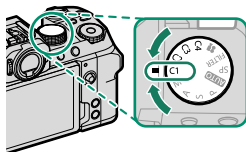

Saving Settings

- 1 Select **IMAGE QUALITY SETTING** in the shooting menu, then highlight **EDIT/SAVE CUSTOM SETTING** and press **MENU/OK**.
- 2 Highlight **EDIT/CHECK SETTING** and press **MENU/OK**.

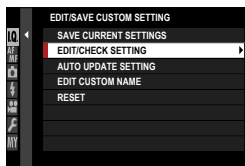

- To store current camera settings in any of custom settings banks 1 through 4, select **SAVE CURRENT SETTINGS**. Previously-saved settings in the selected bank will be overwritten.
- To restore default settings for selected banks, choose **RESET**.
- Banks can be renamed using **EDIT CUSTOM NAME**.
- If **ENABLE** is selected for **AUTO UPDATE SETTING**, changes to settings in modes **C1** through **C4** will automatically be saved to the current bank.

- 3 Highlight a custom settings bank and press **MENU/OK** to select.

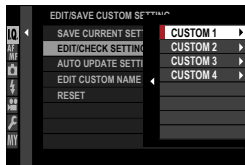

- 4 Highlight an item you wish to store in the custom settings bank and press **MENU/OK**.

Adjust settings for the selected item.

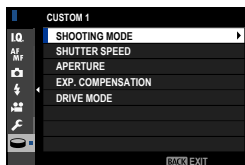

- 5 Press **MENU/OK** to save changes to the selected item and return to the menu item list.

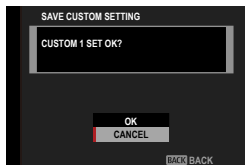

Adjust additional items as desired.

- 6 Pressing **DISP/BACK** in the menu item list displays a confirmation dialog. Highlight **OK** and press **MENU/OK** to save the settings to the selected bank.

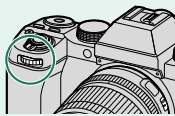
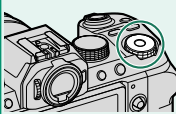
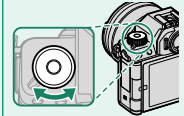

The Command and Function Dials

The roles of the command and Function dials vary with the mode.

	Front command dial	Rear command dial	Fn (function) dial
			
AUTO (AUTO)	Film simulation	Exposure compensation	Film simulation
P (PROGRAM AE)	Program shift		
S (SHUTTER PRIORITY AE)	Shutter speed		
A (APERTURE PRIORITY AE)	Aperture		
M (MANUAL)			
SP (SCENE POSITION)	Scene position	Exposure compensation	
FILTER (FILTER)	Program shift		Filter selection
C1/C2/C3/C4 (CUSTOM)	Varies with exposure mode		
 (MOVIE)			

 The role performed by the function dial can be chosen using **▶ BUTTON/DIAL SETTING > FUNCTION (Fn) SETTING** (📖 223).

Autofocus

Take pictures using autofocus.

- 1 Use **AF/MF SETTING** > **FOCUS MODE** to choose a focus mode (📖 71).
- 2 Use **AF/MF SETTING** > **AF MODE** to choose an AF mode (📖 73).
- 3 Select **AF/MF SETTING** > **FOCUS AREA** and choose the position and size of the focus frame (📖 75).

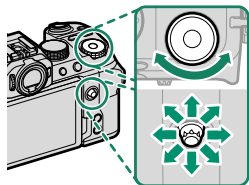



- 4 Take pictures.

Focus Mode

Choose how the camera focuses.

- 1 Press **MENU/OK** to display the menus.
- 2 Select **AF/MF SETTING > FOCUS MODE** in the shooting menu.
- 3 Choose from the following options:

Mode	Description
 MANUAL FOCUS	Focus manually using the lens focus ring. Choose for manual control of focus or in situations in which the camera is unable to focus using autofocus (📖 79).
 CONTINUOUS AF	Focus is continually adjusted to reflect changes in the distance to the subject while the shutter button is pressed halfway. Use for subjects that are in motion.
 SINGLE AF	Focus locks while the shutter button is pressed halfway. Choose for stationary subjects.

- Regardless of the option selected, manual focus will be used when the lens is in manual focus mode.
- If **ON** is selected for **AF/MF SETTING > PRE-AF**, focus will be adjusted continuously in modes **RF-S** and **RF-C** even when the shutter button is not pressed.

The Focus Indicator

Focus status is shown by the focus indicator.

Focus indicator	Focus status
()	Camera focusing.
● (lights green)	Subject in focus; focus locked (focus mode AF-S).
● (lights green)	Subject in focus (focus mode AF-C).
● (blinks white)	Focus is automatically adjusted for changes in distance to subject.
○ (blinks white)	Camera unable to focus.
MF	Manual focus (focus mode MF).

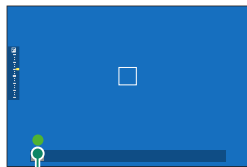

Focus indicator







Autofocus Options (AF Mode)

Choose how the camera focuses in modes **[AF-S]** and **[AF-C]**.



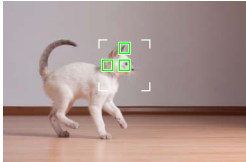

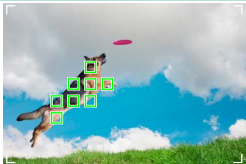



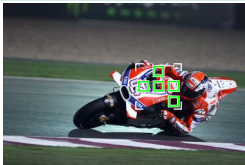

- 1 Press **MENU/OK** and go to the shooting menu.
- 2 Select **[AF/MF] AF/MF SETTING > AF MODE**.
- 3 Choose an AF mode.

How the camera focuses depends on the focus mode.

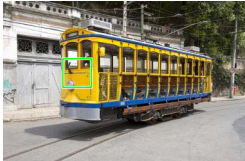
Focus Mode **[AF-S]** (SINGLE AF)

Option	Description	Sample image
 SINGLE POINT	Camera focuses on subject in selected focus point. Use for pin-point focus on selected subject.	
 ZONE	Camera focuses on subject in selected focus zone. Focus zones include multiple focus points, making it easier to focus on subjects in motion.	
 WIDE	Camera focuses automatically on high-contrast subjects; display shows areas in focus.	
 ALL	Rotate the rear command dial in the focus-point selection display (76, 77) to cycle through AF modes in the following order: [SINGLE POINT] , [ZONE] , and [WIDE] .	



Focus Mode (CONTINUOUS AF)

Option	Description	Sample image
 SINGLE POINT	Focus tracks subject at selected focus point. Use for subjects moving toward or away from camera.	
 ZONE	Focus tracks subject in selected focus zone. Use for subjects that are moving fairly predictably.	
 TRACKING	Focus tracks subjects moving through wide area of frame.	
 ALL	Rotate the rear command dial in the focus-point selection display ( 76, 77) to cycle through AF modes in the following order:  SINGLE POINT ,  ZONE , and  TRACKING .	

Focus-Point Selection

Choose a focus point for autofocus.







Viewing the Focus-Point Display

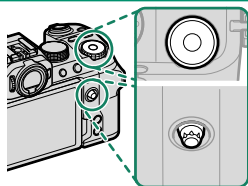







- 1 Press **MENU/OK** and go to the shooting menu.
 - 2 Select  **AF/MF SETTING** > **FOCUS AREA** to view the focus-point display.
 - 3 Use the focus stick (focus lever) and rear command dial to choose a focus area.
-  The focus point can also be selected using touch controls (📖 21).

Selecting a Focus Point

Use the focus stick (focus lever) to choose the focus point and the rear command dial to choose the size of the focus frame. The procedure varies with the option selected for AF mode.







	Focus stick		Rear command dial	DISP/BACK button
AF mode	 Tilt	 Press	 Rotate	
	Highlight focus point	Select highlighted focus point	Choose from 6 frame sizes	Select center focus point
			Choose from 3 frame sizes	
	—			

- Manual focus-point selection is not available when  **WIDE/TRACKING** is selected in focus mode .
- If  **ALL** is selected for AF mode, you can rotate the rear command dial in the focus-point selection display to cycle through AF modes in the following order:  **SINGLE POINT** (6 frame sizes),  **ZONE** (3 frame sizes), and either  **WIDE** (focus mode  **RF-S**) or  **TRACKING** (focus mode  **RF-Q**).

The Focus-Point Display

The focus-point display varies with the option selected for AF mode.

 Focus frames are shown by small squares (□), focus zones by the large squares.

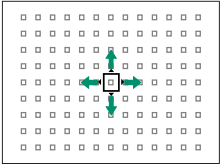
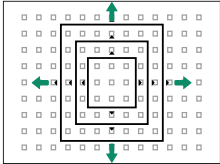
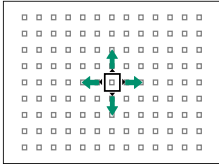
AF mode		
 SINGLE POINT	 ZONE	 WIDE/TRACKING
		
Number of points available can be selected using AF/MF SETTING > NUMBER OF FOCUS POINTS.	Choose from zones with 7×7 , 5×5 , or 3×3 focus points.	Position focus frame over subject you want to track.

Autofocus

Although the camera boasts a high-precision autofocus system, it may be unable to focus on the subjects listed below.

- Very shiny subjects such as mirrors or car bodies.
- Subjects photographed through a window or other reflective object.
- Dark subjects and subjects that absorb rather than reflect light, such as hair or fur.
- Insubstantial subjects, such as smoke or flame.
- Subjects that show little contrast with the background.
- Subjects positioned in front of or behind a high-contrast object that is also in the focus frame (for example, a subject photographed against a backdrop of highly contrasting elements).

Checking Focus

To zoom in on the current focus area for precise focus, press the center of the focus stick (focus lever). Press again to zoom in further and a third time to cancel zoom.

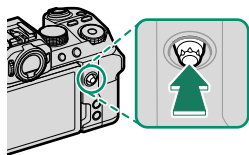

Normal display



Focus zoom



- In focus mode **[MF-S]**, zoom can be adjusted by rotating the rear command dial.
- In focus mode **[MF-S]**, select **SINGLE POINT** for **AF MODE**.
- Focus zoom is not available in focus mode **[MF-C]** or when **[AF-ON] AF/MF SETTING > PRE-AF** is on.
- Use **[Z] BUTTON/DIAL SETTING > FOCUS LEVER SETTING** to change the function performed by the center of the focus stick (focus lever). **[Z] BUTTON/DIAL SETTING > FUNCTION (Fn) SETTING** can also be used to assign focus zoom to other controls (📖 251).

Manual Focus

Adjust focus manually.

- 1 Select **MANUAL FOCUS** for **AF/MF SETTING > FOCUS MODE**.

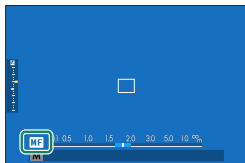

- 2 Focus manually using the lens focus ring. Rotate the ring left to reduce the focus distance, right to increase.

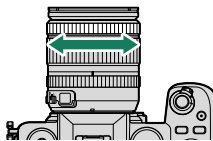

- 3 Take pictures.



- Use **BUTTON/DIAL SETTING > FOCUS RING** to reverse the direction of rotation of the focus ring.
- Regardless of the option selected, manual focus will be used when the lens is in manual focus mode.

Checking Focus

A variety of options are available for checking focus in manual focus mode.

The Manual Focus Indicator

The white line indicates the distance to the subject in the focus area (in meters or feet according to the option selected for **SCREEN SET-UP > FOCUS SCALE UNITS** in the setup menu), the blue bar the depth of field, or in other words the distance in front of and behind the subject that appears to be in focus.

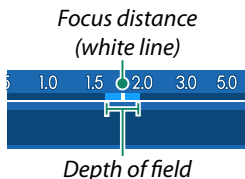
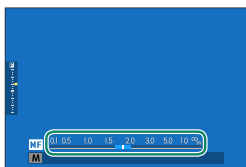

If both **AF DISTANCE INDICATOR** and **MF DISTANCE INDICATOR** are selected in the **SCREEN SET-UP > DISP. CUSTOM SETTING** list, the manual focus indicator can also be viewed using the depth-of-field indicator in the standard display. Use the **DISP/BACK** button to display standard indicators.

Focus Zoom

If **ON** is selected for **AF/MF SETTING > FOCUS CHECK**, the camera will automatically zoom in on the selected focus area when the focus ring is rotated (75). Zoom can be adjusted by rotating the rear command dial. Press the center of the focus stick (focus lever) to exit zoom.

The focus stick can be used to choose the focus area while focus zoom is in effect.

MF Assist

Use **AF/MF SETTING > MF ASSIST** to choose a focus check option.

The following options are available:

- DIGITAL SPLIT IMAGE:** Displays a split image in the center of the frame. Frame the subject in the split-image area and rotate the focus ring until the four parts of the split image are correctly aligned.
- DIGITAL MICROPRISM:** A grid pattern that emphasizes blur is displayed when the subject is out of focus, disappearing to be replaced by a sharp image when the subject is in focus.
- FOCUS PEAK HIGHLIGHT:** Highlights high-contrast outlines. Rotate the focus ring until the subject is highlighted.

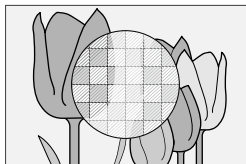
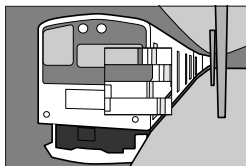

Exposure Compensation

Adjust exposure.

Rotate the rear command dial to adjust exposure.

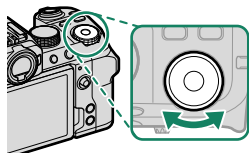

- The amount of compensation available varies with the shooting mode.
- Exposure compensation can be previewed in the shooting display, although the display may not accurately reflect its effects if:
 - the exposure compensation amount exceeds ± 3 EV,
 - 200 **200%** or 400 **400%** is selected for **DYNAMIC RANGE**, or
 - **STRONG** or **WEAK** is selected for **D RANGE PRIORITY**.

Exposure compensation can still be previewed in the viewfinder or LCD monitor by pressing the shutter button halfway. In movie mode, the display may not accurately reflect the effects of exposure compensation during F-log recording or when 200 **200%** or 400 **400%** is selected for **DYNAMIC RANGE**. An accurate preview can be obtained by selecting mode **M** and adjusting exposure directly.

Sensitivity

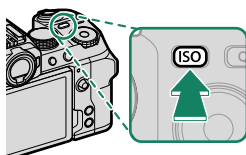

Adjust the camera's sensitivity to light.

To view sensitivity settings, press the **ISO** button.



Option	Description
AUTO1 AUTO2 AUTO3	Sensitivity is automatically adjusted in response to shooting conditions.
160–12800	Adjust sensitivity manually. Selected value is shown in display.
L (80) L (100) L (125) H (25600) H (51200)	Choose for special situations. Note that mottling may appear in pictures taken at H , while L reduces dynamic range.



- Sensitivity is not reset when the camera is turned off.
- Pressing the **ISO** button in  (movie) mode displays the  **MOVIE SETTING** >  **ISO** item in the movie menus.

Adjusting Sensitivity

High values can be used to reduce blur when lighting is poor, while lower values allow slower shutter speeds or wider apertures in bright light; note, however, that mottling may appear in pictures taken at high sensitivities.

Auto Sensitivity (A)

Choose the base sensitivity, maximum sensitivity, and minimum shutter speed for **AUTO1**, **AUTO2**, and **AUTO3**.

Item	Options	Default		
		AUTO1	AUTO2	AUTO3
DEFAULT SENSITIVITY	160–12800	160		
MAX. SENSITIVITY	400–12800	800	3200	12800
MIN. SHUTTER SPEED	1/500–1/4 SEC, AUTO	AUTO		

The camera automatically chooses a sensitivity between the default and maximum values; sensitivity is only raised above the default value if the shutter speed required for optimal exposure would be slower than the value selected for **MIN. SHUTTER SPEED**.







- If the value selected for **DEFAULT SENSITIVITY** is higher than that selected for **MAX. SENSITIVITY**, **DEFAULT SENSITIVITY** will be set to the value selected for **MAX. SENSITIVITY**.
- The camera may select shutter speeds slower than **MIN. SHUTTER SPEED** if pictures would still be underexposed at the value selected for **MAX. SENSITIVITY**.
- If **AUTO** is selected for **MIN. SHUTTER SPEED**, the camera will automatically choose a minimum shutter speed fast enough to prevent blur caused by subject motion or camera shake (the minimum shutter speed is not affected by the option selected for image stabilization).

Metering

Choose how the camera meters exposure.

SHOOTING SETTING > PHOTOMETRY offers a choice of the following metering options:

 The selected option will only take effect when **AF/MF SETTING > FACE/EYE DETECTION SETTING** is **OFF**.

Mode	Description
 MULTI	The camera instantly determines exposure based on an analysis of composition, color, and brightness distribution. Recommended in most situations.
 CENTER WEIGHTED	The camera meters the entire frame but assigns the greatest weight to the area at the center.
 SPOT	The camera meters lighting conditions in an area equivalent to 2% of the frame. Recommended with backlit subjects and in other cases in which the background is much brighter or darker than the main subject.
 AVERAGE	Exposure is set to the average for the entire frame. Provides consistent exposure across multiple shots with the same lighting, and is particularly effective for landscapes and portraits of subjects dressed in black or white.

 To meter the subject in the selected focus area, choose **ON** for **AF/MF SETTING > INTERLOCK SPOT AE & FOCUS AREA** (📖 133).

Focus/Exposure Lock

Focus and exposure lock when the shutter button is pressed halfway.

- 1 Position the subject in the focus frame and press the shutter button halfway to lock focus and exposure. Focus and exposure will remain locked while the shutter button is pressed halfway (AF/AE lock).

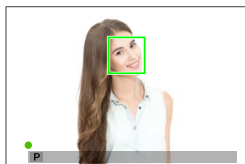

- 2 Press the button all the way down.

 Focus and exposure lock via the shutter button is only available when **ON** is selected for **☑️ BUTTON/DIAL SETTING > SHUTTER AF, SHUTTER AE**.

Other Controls

Focus and exposure can also be locked using function buttons. At default settings, you can use the **AEL** button to lock exposure without locking focus. If the **AFON** button is assigned **AF LOCK ONLY** (📖 251), it can similarly be used to lock focus without locking exposure.

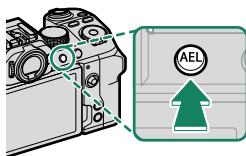

AEL button
(exposure lock)

- While the assigned control is pressed, pressing the shutter button halfway will not end the lock.
- If **AE&AF ON/OFF SWITCH** is selected for **FUNCTION/DIAL SETTING > AE/AF-LOCK MODE**, the lock can only be ended by pressing the control a second time.

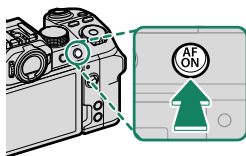

AFON button

- The focus lever (focus stick) can be used to reposition the focus point during exposure lock.
- Function buttons can be assigned other roles using **FUNCTION/DIAL SETTING > FUNCTION (Fn) SETTING**. Exposure and focus lock can also be assigned to other function buttons (📖 251).



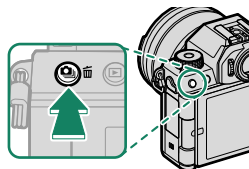

Bracketing

Automatically vary settings over a series of pictures.

- 1 Press the  (drive) button to display drive-mode menu.



- 2 Press the focus stick (focus lever) up or down to highlight one of the following:

Option		Option	
 ISO BKT	89	BKT Bracketing	90
 WHITE BALANCE BKT	89		

- 3 Press the focus stick left or right to highlight the desired bracketing settings.
- 4 Press **MENU/OK** to select.
- 5 Take pictures.

ISO| ISO BKT

Select a bracketing amount ($\pm\frac{1}{3}$, $\pm\frac{2}{3}$, or ± 1) in the drive mode display. Each time the shutter is released, the camera will take a picture at the current sensitivity and process it to create two additional copies, one with sensitivity raised and the other with sensitivity lowered by the selected amount.

WB| WHITE BALANCE BKT

Select a bracketing amount (± 1 , ± 2 , or ± 3) in the drive mode display. Each time the shutter is released, the camera takes one shot and processes it to create three copies: one at the current white balanced setting, one with fine-tuning increased by the selected amount, and another with fine-tuning decreased by the selected amount.

BKT Bracketing

AE BKT

Use  **SHOOTING SETTING > AE BKT SETTING** to choose the bracketing amount, bracketing order, and number of shots. The camera will take the specified number of shots in sequence: one using the metered value for exposure and the others over- or under-exposed by multiples of the selected bracketing amount.

 Regardless of the bracketing amount, exposure will not exceed the limits of the exposure metering system.

FILM SIMULATION BKT

Each time the shutter is released, the camera takes one shot and processes it to create copies with different film simulation settings, chosen using  **SHOOTING SETTING > FILM SIMULATION BKT**.

DYNAMIC RANGE BKT

Each time the shutter button is pressed, the camera takes three shots with different dynamic ranges: 100% for the first, 200% for the second, and 400% for the third.

 While dynamic range bracketing is in effect, sensitivity will be restricted to a minimum of ISO 640; the sensitivity previously in effect is restored when bracketing ends.

FOCUS BKT

Each time the shutter button is pressed, the camera takes a series of photos, varying focus with each shot. The **SHOOTING SETTING > FOCUS BKT SETTING** item offers a choice of **MANUAL** and **AUTO** bracketing.

- Do not adjust zoom during shooting.
- Use of a tripod is recommended.

MANUAL

In **MANUAL** mode, you choose the following.

Option	Description
FRAMES	Choose the number of shots.
STEP	Choose the amount focus changes with each shot.
INTERVAL	Choose the interval between shots.

Focus and FRAMES/STEP

The relation between focus and the options chosen for **FRAMES** and **STEP** is shown in the illustration.

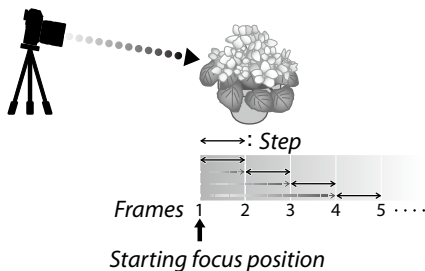



- Focus proceeds from the starting position toward infinity.
- Small **STEP** values translate to small changes in focus, larger values to larger changes.
- Regardless of the option chosen for **FRAMES**, shooting ends when focus reaches infinity.

AUTO

In **AUTO** mode, the camera calculates **FRAMES** and **STEP** automatically.

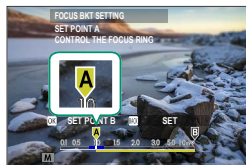
- 1 Select **SHOOTING SETTING** in the shooting menu, highlight **FOCUS BKT SETTING**, and press **MENU/OK**.
- 2 Select **AUTO** and choose an **INTERVAL**.
The view through the lens will be displayed.
- 3 Focus on the nearest end of the subject and press **MENU/OK**.
The selected focus distance appears as **A** on the focus distance indicator.



 The same focus range can be chosen by focusing on the farthest end of the subject first.

- 4 Focus on the farthest end of the subject and press **DISP/BACK**.
The selected focus distance (**B**) and focus range (**A** to **B**) appear on the focus distance indicator.

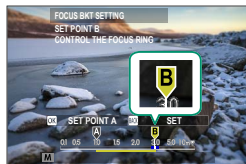

 Instead of pressing the **DISP/BACK** button, you can press **MENU/OK** and select **A** again.

- 5 Take photographs.
The camera will calculate values for **FRAMES** and **STEP** automatically. The number of frames will appear in the display.



Continuous Shooting (Burst Mode)

Capture motion in a series of pictures.

- 1 Press the  (drive) button to display drive-mode menu and select **CH HIGH SPEED BURST** or **CL LOW SPEED BURST**.

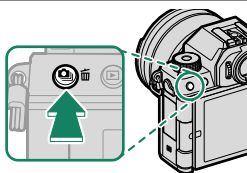

- 2 Choose the frame advance rate and press the shutter button to start shooting.
Shooting ends when the shutter button is released or the memory card is full.

- ! • Frame advance rates of 10 fps or faster are available only when **ES ELECTRONIC SHUTTER** is selected for **SHOOTING SETTING > SHUTTER TYPE**.
- If file numbering reaches 999 before shooting is complete, the remaining pictures will be recorded to a new folder.
- Shooting ends when the memory card is full; the camera will record all photos shot to that point. Burst shooting may not begin if the space available on the memory card is insufficient.
- Frame rates may slow as more shots are taken.
- Frame rate varies with the scene, shutter speed, sensitivity, and focus mode.
- Depending on shooting conditions, frame rates may slow or the flash may not fire.
- Recording times may increase during burst shooting.

Exposure

To vary exposure with each shot, select **OFF** for **SHOOTING SETTING > SHUTTER AE**.

-  Depending on such factors as aperture, sensitivity, and exposure compensation, exposure may not be adjusted automatically.

HDR

Each time the shutter button is pressed, the camera takes three shots, varying exposure each time, and combines them into a single picture. The resulting photograph preserves details in highlights and shadows.

- 1 Press the  (drive) button and select HDR in the drive-mode menu.

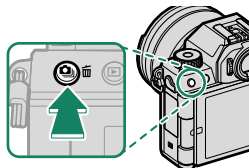



- 2 Choose the amount the brightnesses of the exposures vary.

Option	Description
HDR AUTO	Dynamic range is automatically set to a value of from 200% to 800%.
HDR200	Dynamic range is set to 200%.
HDR400	Dynamic range is set to 400%.
HDR800	Dynamic range is set to 800%.
HDR800+	Camera settings are adjusted for maximum variation in dynamic range.

- 3 Take photographs.
The camera will create a combined image.

- ❗ • Keep the camera steady.
- The desired results may not be achieved if the subject moves or the composition or lighting changes during shooting.
- The picture will be cropped a very small amount and the resolution will drop slightly.
- Mottling may appear in pictures taken at higher values. Choose a value according to the scene.
- “Extended” sensitivity values are not supported.
- Depending on the options selected for HDR and sensitivity, pictures may not be taken at the selected shutter speed.
- The flash does not fire.

 HDR images are indicated by a  icon during playback.

Panoramas

Follow an on-screen guide to create a panorama.

- 1 Press the  (drive) button and select **PANORAMA** in the drive-mode menu.

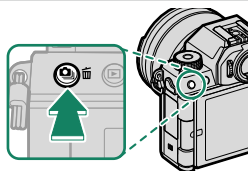

- 2 To select the size of the angle through which you will pan the camera while shooting, press the focus stick (focus lever) left. Highlight a size and press **MENU/OK**.
- 3 Press the focus stick right to view a choice of pan directions. Highlight a pan direction and press **MENU/OK**.
- 4 Press the shutter button all the way down to start recording. There is no need to keep the shutter button pressed during recording.

- 5 Pan the camera in the direction shown by the arrow. Shooting ends automatically when the camera is panned to the end of the guides and the panorama is complete.

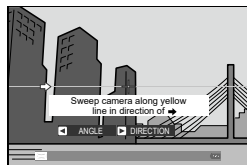

For Best Results

- Move the camera slowly in a small circle at a steady speed
- Keep the camera parallel or at right angles to the horizon and be sure to pan only in the direction shown by the guides
- Try panning at a different speed if the desired results are not achieved
- Prop your elbows against your sides
- Use a tripod
- For best results, use a lens with a focal length of 35 mm or less (50 mm or less in 35 mm format).

- ❗ • If the shutter button is pressed all the way down before the panorama is complete, shooting will end and no panorama may be recorded.
- The last part of the panorama may not be recorded if shooting ends before the panorama is complete.
- Panoramas are created from multiple frames, and the camera may in some cases be unable to stitch the frames together perfectly.
- Panoramas may be blurred if the subject is poorly lit.
- Shooting may be interrupted if the camera is panned too quickly or too slowly. Panning the camera in a direction other than that shown cancels shooting.
- The camera may in some cases record a greater or lesser angle than selected.
- The desired results may not be achieved with:
 - Moving subjects
 - Subjects close to the camera
 - Unvarying subjects such as the sky or a field of grass
 - Subjects that are in constant motion, such as waves and waterfalls
 - Subjects that undergo marked changes in brightness
- If **ON** is selected for **📷 BUTTON/DIAL SETTING > SHUTTER AE**, exposure for the entire panorama is determined by the first frame.

Viewing Panoramas

With the panorama displayed full frame, press the focus stick (focus lever) down to start panorama playback. Vertical panoramas will scroll vertically, horizontal panoramas horizontally.

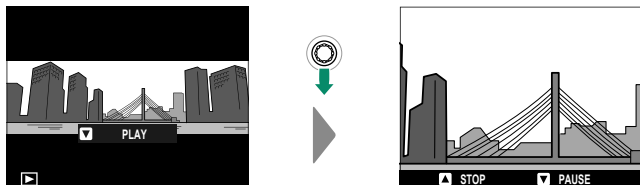



- In full-frame playback, you can use the rear command dial to zoom panoramas in or out.
- Panorama playback is controlled using the focus stick.

Focus stick (focus lever)	Full-frame playback	Panorama playback	Panorama playback paused
Up	—	End playback	
Down	Start playback	Pause playback	Resume playback
Left/right	View other pictures	Choose pan direction	Scroll panorama manually

Multiple Exposures

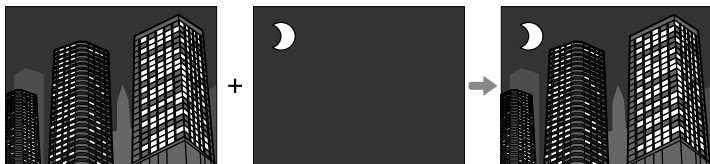
Create a photograph that combines multiple exposures.



- 1 Press the  (drive) button and select **MULTIPLE EXPOSURE** in the drive-mode menu.

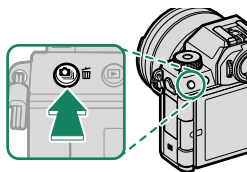

- 2 Choose a blend mode.

Option	Description
ADDITIVE	The camera adds the exposures together. You may need to lower exposure compensation depending on the number of shots.
AVERAGE	The camera automatically optimizes exposure for the final picture. The background in series shot without changing the composition will be optimally exposed.
BRIGHT	The camera compares the exposures and chooses only the brightest pixel at each location. Colors may be mixed depending on their brightness and hue.
DARK	The camera compares the exposures and chooses only the darkest pixel at each location. Colors may be mixed depending on their brightness and hue.

- 3 Take the first shot.

- 4 Press **MENU/OK**. The first shot will be shown superimposed on the view through the lens and you will be prompted to take the second shot.



- To return to the previous step and retake the first shot, press the focus stick (focus lever) left.
- To save the first shot and exit without creating a multiple exposure, press **DISP/BACK**.

- 5 Take the second shot, using the first frame as a guide.



- 6 Press **MENU/OK**. The combined exposures will be displayed as a guide to composing the next shot.



- To return to the previous step and retake the second shot, press the focus stick left.
- To end shooting and create a multiple exposure from the shots taken to this point, press **DISP/BACK**.

- 7 Make additional exposures.
Each photograph can contain up to nine exposures.

- 8 Press **DISP/BACK** to end shooting.
The camera will create the combined image and multiple exposure shooting will end.

Flash Photography

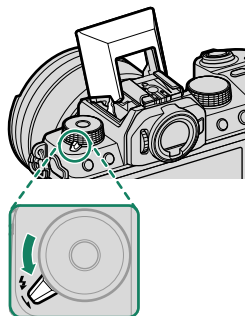

Use the built-in flash for additional lighting when shooting at night or indoors under low light.

- 1 Slide the  lever as shown to raise the flash.

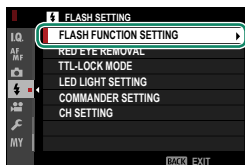

- 2 Select **FLASH FUNCTION SETTING** in the **FLASH SETTING** menu. The camera will display options for the built-in flash.



 Sync terminal options will be displayed if the built-in flash is lowered and either no flash unit, or an incompatible flash unit, is mounted on the hot shoe ( 266). Raise the flash before adjusting settings.

- 3 Highlight items using the focus stick (focus lever) and rotate the rear command dial to change the highlighted setting (📖 103).

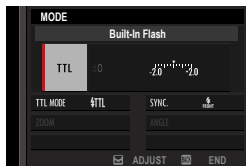

- 4 Press **DISP/BACK** to put the changes into effect.

- ⚠️ Depending on the distance to the subject, some lenses may cast shadows in photos taken with the flash.
 - Be careful not to injure yourself on the edges of the raised flash.
 - The flash will not fire at some settings, for example in panorama mode or when the electronic shutter is used.
 - Choose shutter speeds slower than $\frac{1}{180}$ s when using the flash in exposure mode **S** (shutter-priority AE) or manual (**M**).
- 📄 In TTL mode, the flash may fire several times with each shot. Do not move the camera until shooting is complete.
 - The flash will not fire if **OFF** is selected for **SOUND & FLASH** in the **USER SETTING** menu.

Flash Settings

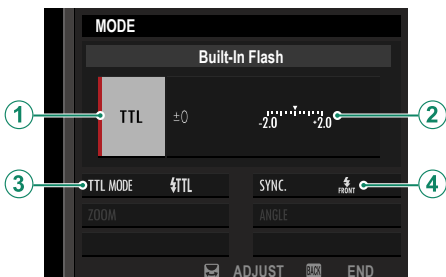

The following settings are available with the built-in flash.



Setting	Description
① Flash control mode	<p>Choose from the following options:</p> <ul style="list-style-type: none"> • TTL: TTL mode. Adjust flash compensation (②) and choose a flash mode (③). • M: The flash fires at the selected output (②) regardless of subject brightness or camera settings. Output is expressed in fractions of full power, from $\frac{1}{4}$ to $\frac{1}{64}$. The desired results may not be achieved at low values if they exceed the limits of the flash control system; take a test shot and check the results. • ☑ (primary flash): Choose if the flash is being used as a primary flash controlling secondly flash units, for example as part of a studio flash system. • ☑ OFF (OFF): The flash does not fire.
② Flash compensation/output	Adjust flash level. The options available vary with the flash control mode (①).

Setting	Description
③ Flash mode (TTL)	<p>Choose a flash mode for TTL flash control. The options available vary with the shooting mode (P, S, A, or M) selected.</p> <ul style="list-style-type: none"> • FLASH AUTO (FLASH AUTO): The flash fires only as required; flash level is adjusted according to subject brightness. A  icon displayed when the shutter button is pressed halfway indicates that the flash will fire when the photo is taken. • STANDARD (STANDARD): The flash fires with every shot if possible; flash level is adjusted according to subject brightness. The flash will not fire if not fully charged when the shutter is released. • SLOW SYNC. (SLOW SYNC.): Combine the flash with slow shutter speeds when photographing portrait subjects against a backdrop of night scenery. The flash will not fire if not fully charged when the shutter is released.
④ Sync	<p>Choose whether the flash is timed to fire immediately after the shutter opens (FRONT/1ST CURTAIN) or immediately before it closes (REAR/2ND CURTAIN). 1ST CURTAIN is recommended in most circumstances.</p>

Red-Eye Removal

Red-eye removal is available when an option other than **OFF** is selected for  **FLASH SETTING > RED EYE REMOVAL** and  **AF/MF SETTING > FACE/EYE DETECTION SETTING** is **FACE DETECTION ON**. Red-eye removal minimizes “red-eye” caused when light from the flash is reflected from the subject’s retinas.

Flash Sync Speed

The flash will synchronize with the shutter at shutter speeds of $\frac{1}{180}$ s or slower.

Optional Flash Units from Fujifilm

The camera can be used with optional Fujifilm shoe-mounted flash units.

Third-Party Flash Units

Do not use third-party flash units that apply over 300 V to the camera hot shoe.

The Shooting Menus

6

IMAGE QUALITY SETTING (Still Photography)

Adjust image quality settings for still photography.

To display image quality settings, press **MENU/OK** in the photo shooting display and select the **IQ** (IMAGE QUALITY SETTING) tab.

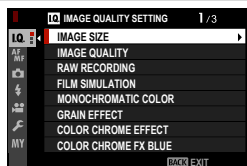

 The options available vary with the shooting mode selected.

IMAGE SIZE

Choose the size and aspect ratio at which still pictures are recorded.

Option	Image size
L 3:2	6240 × 4160
L 16:9	6240 × 3512

Option	Image size
L 1:1	4160 × 4160

Option	Image size
M 3:2	4416 × 2944
M 16:9	4416 × 2488

Option	Image size
M 1:1	2944 × 2944

Option	Image size
S 3:2	3120 × 2080
S 16:9	3120 × 1760

Option	Image size
S 1:1	2080 × 2080

The following options are available in **SPORTS FINDER MODE** and when **1.25X CROP** is selected in burst mode:

Option	Image size
M 3:2	4992 × 3328
M 16:9	4992 × 2808

Option	Image size
M 1:1	3328 × 3328

 **IMAGE SIZE** is not reset when the camera is turned off or another shooting mode is selected.

IMAGE QUALITY

Choose a file format and compression ratio.

Option	Description
FINE	Low compression ratios are used for higher-quality images.
NORMAL	Higher compression ratios are used to increase the number of images that can be stored.
FINE + RAW	Record both RAW and fine-quality JPEG images.
NORMAL + RAW	Record both RAW and normal-quality JPEG images.
RAW	Record RAW images only.

The Function Buttons

To toggle RAW image quality on or off for a single shot, assign **RAW** to a function button (☰ 251). Press the button once to select the option in the right column, again to return to the original setting (left column).

Option currently selected for IMAGE QUALITY	Option selected by pressing function button to which RAW is assigned
FINE	FINE + RAW
NORMAL	NORMAL + RAW
FINE + RAW	FINE
NORMAL + RAW	NORMAL
RAW	FINE





RAW RECORDING















Choose whether to compress RAW images.

Option	Description
UNCOMPRESSED	RAW images are not compressed.
LOSSLESS COMPRESSED	RAW images are compressed using a reversible algorithm that reduces file size with no loss of image data. The images can be viewed in Capture One Express Fujifilm (📖 294), RAW FILE CONVERTER EX powered by SILKYPIX (📖 294), FUJIFILM X RAW STUDIO (📖 295), or other software that supports “lossless” RAW compression. Quality is the same as UNCOMPRESSED , but the resulting files are anywhere from about 30 to 90 percent of their uncompressed size.
COMPRESSED	RAW images are compressed using a “lossy”, non-reversible algorithm. Quality is about the same as UNCOMPRESSED , but the resulting files are anywhere from about 25 to 35 percent of their uncompressed size.

FILM SIMULATION

Simulate the effects of different kinds of film, including black-and-white (with or without color filters). Choose a palette according to your subject and creative intent.

Option	Description
 AUTO	The camera chooses the film simulation. This option is available when the mode dial is rotated to AUTO or SP .
 PROVIA/STANDARD	Ideal for a wide range of subjects.
 Velvia/VIVID	Vibrant reproduction, ideal for landscape and nature.
 ASTIA/SOFT	Softer color and contrast for a more subdued look.
 CLASSIC CHROME	Soft color and enhanced shadow contrast for a calm look.

Option	Description
 PRO Neg. Hi	Ideal for portrait with slightly enhanced contrast.
 PRO Neg. Std	Ideal for portrait with soft gradations and skin tones.
 CLASSIC Neg.	Enhanced color with hard tonality to increase image depth.
 ETERNA/CINEMA	Soft color and rich shadow tone suitable for film look movie.
 ETERNA BLEACH BYPASS	Unique color with low saturation and high contrast. Suitable for still and movie.
 ACROS	Shoot in Black and White In rich details with sharpness. Available with yellow (Ye), red (R), and green (G) filters, which deepen shades of gray corresponding to hues complementary to the selected color. <ul style="list-style-type: none"> •  ACROS+Ye FILTER: Slightly enhances contrast and darkens skies. •  ACROS+R FILTER: Enhances contrast and darkens skies considerably. •  ACROS+G FILTER: Produces pleasing skin tones in portrait.
 MONOCHROME	Shoots in black and white. Available with yellow (Ye), red (R), and green (G) filters, which deepen shades of gray corresponding to hues complementary to the selected color. <ul style="list-style-type: none"> •  MONOCHROME+Ye FILTER: Slightly enhances contrast and darkens skies. •  MONOCHROME+R FILTER: Enhances contrast and darkens skies considerably. •  MONOCHROME+G FILTER: Produces pleasing skin tones in portrait.
 SEPIA	Shoots in sepia tone.



- Film simulation options can be combined with tone and sharpness settings.
- Film simulation settings can also be accessed via shortcuts (📖 242).
- For more information, visit:

https://fujifilm-x.com/global/tag/the-world-of-film-simulation/?post_type=xstories

MONOCHROMATIC COLOR

Add a reddish or bluish tinge (warm or cool color cast) to the **A** ACROS and **B** MONOCHROME monochrome film simulations. Color can be adjusted on the **WARM-COOL** and **G** (Green)-**M** (Magenta) axes.

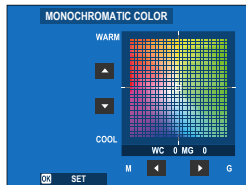

GRAIN EFFECT

Add a film grain effect.

ROUGHNESS

Option	Description
STRONG	Choose for rougher grains.
WEAK	Choose for smoother grains.
OFF	Turn the effect off.

SIZE

Option	Description
LARGE	Choose for coarser grains.
SMALL	Choose for finer grains.

COLOR CHROME EFFECT

Increase the range of tones available for rendering colors that tend to be highly saturated, such as reds, yellows, and greens.

Option	Description
STRONG	Choose for a strong effect.
WEAK	Choose for a weak effect.
OFF	Turn the effect off.













COLOR CHROME FX BLUE

Increase the range of tones available for rendering blues.

Option	Description
STRONG	Choose for a strong effect.
WEAK	Choose for a weak effect.
OFF	Turn the effect off.

WHITE BALANCE

For natural colors, choose a white balance option that matches the light source.

Option	Description
 AUTO WHITE PRIORITY	White balance is adjusted automatically. Choose for whiter whites in scenes lit by incandescent bulbs.
AUTO	White balance is adjusted automatically.
 AUTO AMBIENCE PRIORITY	White balance is adjusted automatically. Choose for warmer whites in scenes lit by incandescent bulbs.
 CUSTOM 1	
 CUSTOM 2	Measure a value for white balance.
 CUSTOM 3	
 COLOR TEMPERATURE	Choose a color temperature.
 DAYLIGHT	For subjects in direct sunlight.
 SHADE	For subjects in the shade.
 FLUORESCENT LIGHT-1	Use under "daylight" fluorescent lights.
 FLUORESCENT LIGHT-2	Use under "warm white" fluorescent lights.
 FLUORESCENT LIGHT-3	Use under "cool white" fluorescent lights.
 INCANDESCENT	Use under incandescent lighting.
 UNDERWATER	Reduces the blue cast typically associated with underwater lighting.

- In conditions in which **AUTO** fails to produce the desired results—for example, under certain types of lighting or in close-ups of portrait subjects—use custom white balance or choose a white balance option suited to the light source.
- White balance is adjusted for flash lighting only in **AUTO**, **WB AUTO WHITE PRIORITY**, **WB AUTO AMBIENCE PRIORITY**, and **WB** modes. Turn the flash off using other white balance options.
- White balance options can also be accessed via shortcuts (📖 242).

Fine-Tuning White Balance

Pressing **MENU/OK** after selecting a white balance option displays a fine-tuning dialog; use the focus stick (focus lever) to fine-tune white balance.

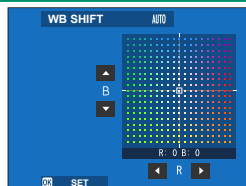

- To exit without fine-tuning white balance, press **DISP/BACK** after selecting a white balance option.
- You cannot tilt the focus stick diagonally when fine-tuning white balance.

Custom White Balance

Choose \mathcal{Q}_1 , \mathcal{Q}_2 , or \mathcal{Q}_3 to adjust white balance for unusual lighting conditions using a white object as a reference (colored objects can also be used to lend photos a color cast). A white balance target will be displayed; position and size the target so that it is filled by the reference object and press the shutter button all the way down to measure white balance (to select the most recent custom value and exit without measuring white balance, press **DISP/BACK**, or press **MENU/OK** to select the most recent value and display the fine-tuning dialog).

- If **“COMPLETED!”** is displayed, press **MENU/OK** to set white balance to the measured value.
- If **“UNDER”** is displayed, raise exposure compensation and try again.
- If **“OVER”** is displayed, lower exposure compensation and try again.

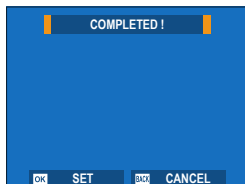
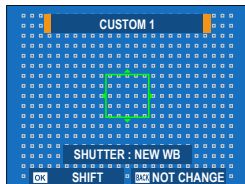

K: Color Temperature

Changing the color temperature changes overall hue.

 Color temperature can be adjusted to make pictures “warmer” or “colder” or deliberately produce colors that differ radically from those in real life.

- 1 Select **K** in the white balance menu. The option currently selected for color temperature will be displayed.

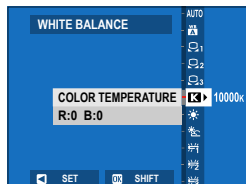

- 2 Edit the color temperature using the focus stick (focus lever) and press **MENU/OK**. A fine-tuning dialog will be displayed.

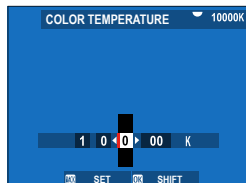

-  You can also adjust color temperature in increments of 10 K by rotating the rear command dial.
- Choose from values of from 2500 to 10000 K.
- To exit without fine-tuning white balance, press **DISP/BACK** after choosing a color temperature.

- 3 Highlight a fine-tuning amount using the focus stick.
- 4 Press **MENU/OK**. The changes will be applied. The selected color temperature will appear in the display.

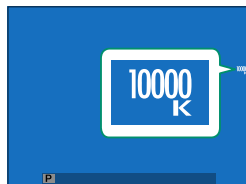

Color Temperature





Color temperature is an objective measure of the color of a light source, expressed in Kelvin (K). Light sources with a color temperature close to that of direct sunlight appear white; light sources with a lower color temperature have a yellow or red cast, while those with a higher color temperature are tinged with blue.

DYNAMIC RANGE

Control contrast. Choose lower values to increase contrast when shooting indoors or under overcast skies, higher values to reduce loss of detail in highlights when photographing high-contrast scenes. Higher values are recommended for scenes that include both sunlight and deep shade, for such high-contrast subjects as sunlight on water, brightly-lit autumn leaves, and portraits taken against a blue sky, and for white objects or people wearing white.

Options			
AUTO	 100%	 200%	 400%

 Mottling may appear in pictures taken at higher values. Choose a value according to the scene.

-  If **AUTO** is selected, the camera will automatically choose either  **100%** or  **200%** according to the subject and shooting conditions. Shutter speed and aperture will be displayed when the shutter button is pressed halfway.
-  **200%** is available at sensitivities of from ISO 320 to ISO 12800,  **400%** at sensitivities of from ISO 640 to 12800.

D RANGE PRIORITY

Reduce loss of detail in highlights and shadows for natural-looking results when photographing high-contrast scenes.

Option	Description
AUTO	Contrast is adjusted automatically in response to lighting conditions.
STRONG	Adjust dynamic range by a large amount for very high-contrast scenes.
WEAK	Adjust dynamic range by a smaller amount for moderately high-contrast scenes.
OFF	Contrast reduction off.

- **WEAK** is available at sensitivities of from ISO 320 to ISO 12800, **STRONG** at sensitivities of from ISO 640 to 12800.
- When an option other than **OFF** is selected, **TONE CURVE**, and **DYNAMIC RANGE** will be adjusted automatically.

TONE CURVE

With reference to a tone curve, adjust the appearance of highlights or shadows, making them harsher or softer. Choose higher values to make shadows and highlights harsher, lower values to make them softer.

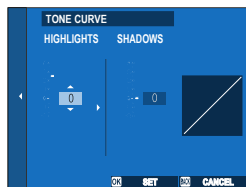

Option	Description
HIGHLIGHTS	-2 to +4
SHADOWS	-2 to +4

COLOR

Adjust color density. Choose higher values to increase saturation, lower values to reduce it.

Options								
-4	-3	-2	-1	0	+1	+2	+3	+4

SHARPNESS

Sharpen or soften outlines. Choose higher values for sharper outlines, lower values for softer outlines.

Options								
-4	-3	-2	-1	0	+1	+2	+3	+4

HIGH ISO NR

Reduce noise in pictures taken at high sensitivities. Choose higher values to reduce noise and smooth outlines, lower values to leave outlines visible.

Options								
-4	-3	-2	-1	0	+1	+2	+3	+4

CLARITY

Increase definition while altering tones in highlights and shadows as little as possible. Choose higher values for increased definition, lower values for a softer effect.

Options										
-5	-4	-3	-2	-1	0	+1	+2	+3	+4	+5

 The additional processing required at settings other than 0 increases the time need to save each shot.

 Clarity is adjusted automatically when the mode dial is rotated to **AUTO** or **SP**.

LONG EXPOSURE NR

Select **ON** to reduce mottling in long time-exposures.

Options	
ON	OFF

 The additional processing required when **ON** is selected increases save times.

LENS MODULATION OPTIMIZER

Select **ON** to improve definition by adjusting for diffraction and the slight loss of focus at the periphery of the lens.

Options	
ON	OFF

COLOR SPACE

Choose the gamut of colors available for color reproduction.

Option	Description
sRGB	Recommended in most situations.
Adobe RGB	For commercial printing.

PIXEL MAPPING

Use this option if you notice bright spots in your pictures.

- 1 Press **MENU/OK** in the shooting display and select the  **IMAGE QUALITY SETTING** tab.
- 2 Highlight **PIXEL MAPPING** and press **MENU/OK** to perform pixel mapping.

-  • Results are not guaranteed.
- Be sure the battery is fully charged before beginning pixel mapping.
- Pixel mapping is not available when the camera temperature is elevated.
- Processing may take a few seconds.

EDIT/SAVE CUSTOM SETTING

Save custom camera settings for commonly-encountered situations. Saved settings can be recalled by rotating the mode dial to positions **C1 (CUSTOM 1)** through **C4 (CUSTOM 4)** (📖 67).

📷 MOUNT ADAPTER SETTING

Adjust settings for lenses attached via a mount adapter. The camera can store settings for multiple lenses (**LENS 1** through **LENS 6**).

📄 Any changes made using this item also apply in movie mode (📖 166).

Choosing a Focal Length

Enter the lens's true focal length.

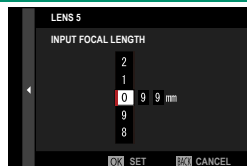

Distortion Correction

Choose from **STRONG**, **MEDIUM**, or **WEAK** options to correct **BARREL** or **PINCUSHION** distortion.



Color Shading Correction

Color (shading) variations between the center and edges of the frame can be adjusted separately for each corner.

To use color shading correction, follow the steps below.

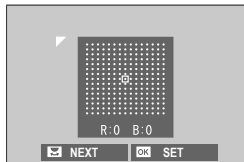



- 1 Rotate the rear command dial to choose a corner. The selected corner is indicated by a triangle.
- 2 Use the focus stick (focus lever) to adjust shading until there is no visible difference in color between the selected corner and the center of the image.
 - Press the focus stick left or right to adjust colors on the cyan–red axis.
 - Press the focus stick up or down to adjust colors on the blue–yellow axis.

 To determine the amount required, adjust color shading correction while taking photos of blue sky or a sheet of gray paper.

Peripheral Illumination Correction

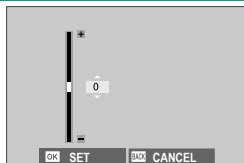
Choose from values between -5 and $+5$. Choosing positive values increases peripheral illumination, while choosing negative values reduces peripheral illumination. Positive values are recommended for vintage lenses, negative values to create the effect of images taken with an antique lens or a pinhole camera.



 To determine the amount required, adjust peripheral illumination correction while taking photos of blue sky or a sheet of gray paper.

EDIT LENS NAME

Change the lens name.

AF/MF SETTING (Still Photography)

Adjust focus settings for still photography.

To display AF/MF settings, press **MENU/OK** in the photo shooting display and select the **AF/MF** (AF/MF SETTING) tab.

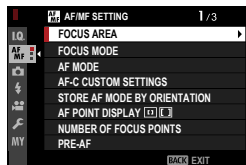

 The options available vary with the shooting mode selected.

FOCUS AREA

Choose the focus area for autofocus, manual focus, and focus zoom ( 75).

FOCUS MODE

Choose how the camera focuses ( 71).

AF MODE

Choose how the camera focuses in modes **AF-S** and **AF-L** ( 73).

AF-C CUSTOM SETTINGS

Select focus-tracking options for **CONTINUOUS AF** focus mode. Choose from Sets 1 (**SET 1**) through 5 (**SET 5**) according to your subject or select **SET 6 CUSTOM** for custom focus-tracking options.

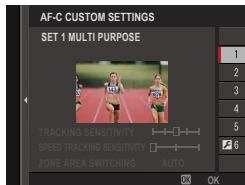

Option	Description
SET 1 MULTI PURPOSE	A standard tracking option that works well with the typical range of moving subjects.
SET 2 IGNORE OBSTACLES & CONTINUE TO TRACK SUBJECT	The focus system attempts to track the chosen subject. Choose with subjects that are hard to keep in the focus area or if other objects are likely to enter the focus area with the subject.
SET 3 FOR ACCELERATING/ DECELERATING SUBJECT	The focus system attempts to compensate for subject acceleration or deceleration. Choose for subjects prone to rapid changes in velocity.
SET 4 FOR SUDDENLY APPEARING SUBJECT	The focus system attempts to focus quickly on subjects entering the focus area. Choose for subjects that appear abruptly or when rapidly switching subjects.
SET 5 FOR ERRATICALLY MOVING & ACCEL./DECEL. SUBJECT	Choose for hard-to-track subjects prone not only to sudden changes in velocity but also to large movements front to back and left to right.
SET 6 CUSTOM	Adjust TRACKING SENSITIVITY , SPEED TRACKING SENSITIVITY , and ZONE AREA SWITCHING to suit your preferences based on the values for Sets 1–5 (📖 124, 126).

Focus Tracking Options

The individual parameters that are part of a focus tracking set are described below.

TRACKING SENSITIVITY

This parameter determines how long the camera waits to switch focus when an object enters the focus area behind or in front of the current subject. The higher the value, the longer the camera will wait.

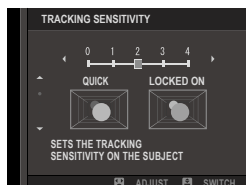

Options

0 1 2 3 4

- ! The higher the value, the longer it takes the camera to refocus when you attempt to switch subjects.
- The lower the value, the more likely the camera is to switch focus from your subject to other objects in the focus area.

SPEED TRACKING SENSITIVITY

This parameter determines how sensitive the tracking system is to changes in subject velocity. The higher the value, the greater the precision with which the system attempts to respond to sudden movement.

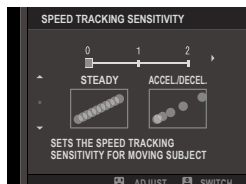

Options

0 1 2



- ! The higher the value, the more difficulty the camera will have focusing in situations in which autofocus does not perform well, such as when the subject is highly reflective or low in contrast.

ZONE AREA SWITCHING

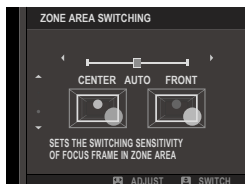
This parameter determines the focus area given priority in zone AF.



Option	Description
FRONT	Zone AF assigns priority to the subjects closest to the camera.
AUTO	The camera locks focus on the subject at the center of the zone and then switches focus areas as necessary to track it.
CENTER	Zone AF assigns priority to subjects in the center of the zone.

 This option takes effect only when  **ZONE** is selected for AF mode.

Set Values

Parameter values for the different sets are listed below.

	TRACKING SENSITIVITY	SPEED TRACKING SENSITIVITY	ZONE AREA SWITCHING
SET 1	2	0	AUTO
SET 2	3	0	CENTER
SET 3	2	2	AUTO
SET 4	0	1	FRONT
SET 5	3	2	AUTO

Custom Focus Tracking Options

Follow the steps below to adjust settings for Set 6.

- 1 Select **AF-C CUSTOM SETTINGS > SET 6 CUSTOM**.

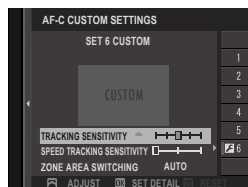

- 2 Highlight items using the focus stick (focus lever) and rotate the front command dial to change. To reset settings to their original values, press .
- 3 Press **DISP/BACK** when settings are complete.

STORE AF MODE BY ORIENTATION

Choose whether the AF mode used when the camera is in portrait orientation is stored separately from that used when the camera is in landscape orientation.

Option	Description
OFF	The same settings are used in both orientations.
FOCUS AREA ONLY	The focus area for each orientation can be selected separately.
ON	The focus mode and focus area can be selected separately.

AF POINT DISPLAY

Choose whether individual focus frames are displayed when **ZONE** or **WIDE/TRACKING** is selected for  **AF/MF SETTING** > **AF MODE**.

Options	
ON	OFF

NUMBER OF FOCUS POINTS

Choose the number of focus points available for focus-point selection in manual focus mode or when **SINGLE POINT** is selected for **AF MODE**.

Option	Description
117 POINTS (9 × 13)	Choose from 117 focus points arranged in a 9- by 13-point grid.
425 POINTS (17 × 25)	Choose from 425 focus points arranged in a 17- by 25-point grid.

PRE-AF

If **ON** is selected, the camera will continue to adjust focus even when the shutter button is not pressed halfway. The camera adjusts focus continuously, allowing it to focus faster when the shutter button is pressed halfway. Choosing this option helps prevent missed shots.

Options	
ON	OFF



 Choosing **ON** increases the drain on the battery.

AF ILLUMINATOR

If **ON** is selected, the AF-assist illuminator will light to assist autofocus.

Options	
ON	OFF





-  • The camera may be unable to focus using the AF-assist illuminator in some cases.
- If the camera is unable to focus, try increasing the distance to the subject.
 - Avoid shining the AF-assist illuminator directly into your subject's eyes.

 Any changes made using this item also apply in movie mode ( 168).

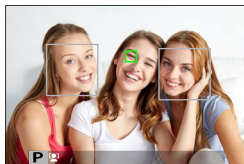
FACE/EYE DETECTION SETTING





If the camera detects human faces, it will assign them priority over the background and adjust settings appropriately for portraits when setting focus and exposure. You can also choose whether the camera focuses on the left or right eye when face detection is on.



Option	Description
FACE DETECTION ON	Adjust settings for Intelligent Face Detection. You can also adjust eye detection settings. <ul style="list-style-type: none"> •  EYE OFF: Intelligent Face Detection only. •  EYE AUTO: The camera automatically chooses which eye to focus on when a face is detected. •  RIGHT EYE PRIORITY: The camera focuses on the right eye of subjects detected using Intelligent Face Detection. •  LEFT EYE PRIORITY: The camera focuses on the left eye of subjects detected using Intelligent Face Detection.
OFF	Intelligent Face Detection and eye priority off.



- 
 • If the subject moves as the shutter button is pressed, the face may not be in the area indicated by the green border when the picture is taken.
- In some modes, the camera may set exposure for the frame as a whole rather than the portrait subject.



- The face selected by the camera is indicated by a green border. Any other faces detected by the camera are indicated by gray borders. To have the camera focus on a different subject, tap inside the gray border. The  icon will change from white to green.
- When **DIRECT AF POINT SELECTION/FACE SELECT** is chosen for **▶ BUTTON/DIAL SETTING > FOCUS LEVER SETTING > TILT** , you can also switch subjects using the focus stick (focus lever) or (during viewfinder photography) touch controls ( 21).
- To switch from face detection to manual focus-area selection, press the center of the focus stick (focus lever). Press again to re-enable face detection.
- If the selected subject leaves the frame, the camera will wait a set time for its return and consequently the green frame may sometimes appear in locations where no face is seen.
- You cannot switch subjects during burst photography.
- Depending on shooting conditions, face selection may be suspended at the close of burst shooting.
- Faces can be detected with the camera in vertical or horizontal orientation.
- If the camera is unable to detect the subject's eyes because they are hidden by hair, glasses, or other objects, the camera will instead focus on faces.
- Face/eye detection options can also be accessed via shortcuts ( 242).

AF+MF

If **ON** is selected in focus mode  and focus has been locked (whether by pressing the shutter button halfway or by other means), focus lock can be ended and focus adjusted manually by rotating the focus ring.

Options	
ON	OFF
<p> • Lenses with a focus distance indicator must be set to manual focus mode (MF) before this option can be used. Selecting MF disables the focus distance indicator.</p> <p>• If the lens is equipped with a focus distance indicator, set the focus ring to the center, as the camera may fail to focus if the ring is set to infinity or the minimum focus distance.</p> <p> STANDARD and FOCUS PEAK HIGHLIGHT MF assist options can be selected using MF ASSIST.</p>	

AF + MF Focus Zoom

When **ON** is selected for  **AF/MF SETTING** > **FOCUS CHECK** and **SINGLE POINT** selected for **AF MODE**, focus zoom can be used to zoom in on the selected focus area. The zoom ratio can be selected using the rear command dial.

MF ASSIST

Choose how focus is displayed in manual focus mode.

Option	Description
STANDARD	Focus is displayed normally (focus peaking, digital split image, and digital microprism are not available).
DIGITAL SPLIT IMAGE	Displays a black-and-white (MONOCHROME) or color (COLOR) split image in the center of the frame. Frame the subject in the split-image area and rotate the focus ring until the four parts of the split image are correctly aligned.
DIGITAL MICROPRISM	A grid pattern that emphasizes blur is displayed when the subject is out of focus, disappearing to be replaced by a sharp image when the subject is in focus.
FOCUS PEAK HIGHLIGHT	The camera heightens high-contrast outlines. Choose a color and peaking level.

FOCUS CHECK

If **ON** is selected, the display will automatically zoom in on the selected focus area when the focus ring is rotated in manual focus mode.

Options	
ON	OFF



- Press the focus stick (focus lever) to cancel focus zoom.
- The zoom position is centered on the current focus area and changes when the focus area is changed.

INTERLOCK SPOT AE & FOCUS AREA



Select **ON** to meter the current focus frame when **SINGLE AF** or **CONTINUOUS AF** is selected for **FOCUS MODE**.

Options	
ON	OFF

INSTANT AF SETTING

Chooses how the camera focuses when a button to which focus lock or **AF-ON** is assigned is pressed with **MANUAL FOCUS** selected for **FOCUS MODE**.



Options	
AF-S	AF-C

 Any changes made using this item also apply in movie mode ( 170).

DEPTH-OF-FIELD SCALE

Choose **FILM FORMAT BASIS** to help you make practical assessments of depth of field for pictures that will be viewed as prints and the like, **PIXEL BASIS** to help you assess depth of field for pictures that will be viewed at high resolutions on computers or other electronic displays.

Options	
PIXEL BASIS	FILM FORMAT BASIS

 Any changes made using this item also apply in movie mode ( 170).

RELEASE/FOCUS PRIORITY

Choose how the camera focuses when the shutter button is pressed all the way down with **SINGLE AF** or **CONTINUOUS AF** selected for **FOCUS MODE**.



Option	Description
RELEASE	Shutter response is prioritized over focus. Pictures can be taken when the camera is not in focus.
FOCUS	Focus is prioritized over shutter response. Pictures can be only taken when the camera is in focus.

AF RANGE LIMITER

Limit the range of available focus distances for increased focus speed.





Option	Description
OFF	Focus limiter disabled.
CUSTOM	Limit focus to a range of distances defined by a minimum and maximum. <ul style="list-style-type: none">• OK: Limit focus to the selected range.• SET: Choose two objects and limit focus to the distance between them.
PRESET1 PRESET2	Limit focus to a preset range.



-  Choosing a focus range that includes distances shorter than the minimum focus distance of the lens disables the focus limiter.
- The values listed and displayed for the focus limiter may differ from the actual focus distance.

-  The following additional operations can be performed when **CUSTOM** is selected:
 - You can tap objects in the touch screen display to choose the focus range.
 - Instead of tapping an object in the display, you set the maximum focus distance to infinity by rotating the focus ring.
- Any changes made using this item also apply in movie mode ( 170).

TOUCH SCREEN MODE

Choose the shooting operations performed using touch controls.

Mode	Description
 TOUCH SHOOTING	Tap your subject in the display to focus and release the shutter. In burst mode, pictures will be taken while you keep your finger on the display.
 AF  AF OFF	<ul style="list-style-type: none"> • In focus mode S (AF-S), the camera focuses when you tap your subject in the display. Focus locks at the current distance until you tap the AF OFF icon. • In focus mode C (AF-C), the camera initiates focus when you tap your subject display. The camera will continue to adjust focus for changes in the distance to the subject until you tap the AF OFF icon. • In manual focus mode (MF), you can tap the display to focus on the selected subject using autofocus.
 AREA	Tap to select a point for focus or zoom. The focus frame will move to the selected point.
 OFF	Touch controls disabled.

- To disable touch controls and hide the touch screen mode indicator, select **OFF** for  **BUTTON/DIAL SETTING > TOUCH SCREEN SETTING > TOUCH SCREEN SETTING**.
- Any changes made using this item also apply in movie mode ( 171).

Touch Controls for Focus Zoom

Different touch controls are used during focus zoom (focus check enabled).

Central Area

Tapping the center of the display performs the operations below.

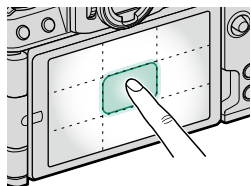

Mode	Operation performed
TOUCH SHOOTING	SINGLE AF/MANUAL FOCUS: Take a picture
AF	SINGLE AF: AF
	MANUAL FOCUS: Instant AF
AREA	SINGLE AF: AF
	MANUAL FOCUS: Instant AF
OFF	SINGLE AF/MANUAL FOCUS: OFF

Other Areas

Tapping other areas simply scrolls the display, whether during still photography or movie recording and regardless of the option selected for touch screen mode.

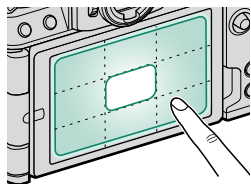

SHOOTING SETTING (Still Photography)

Adjust shooting options for still photography.

To display shooting settings, press **MENU/OK** in the photo shooting display and select the  (**SHOOTING SETTING**) tab.

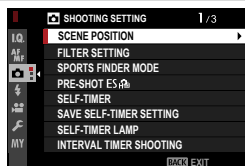

SCENE POSITION

Choose a scene for **SP** mode ( 64).

FILTER SETTING

Choose the filter used when the mode dial is rotated to **FILTER** ( 66).

SPORTS FINDER MODE

Take pictures using the crop in the center of the display. Choose this option for pictures of athletes, birds, and other moving subjects.

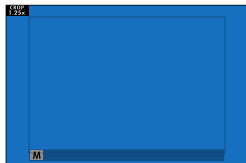

Option	Description
ON	Pictures are taken using a 1.25× crop, reducing the picture angle by an amount equivalent to increasing lens focal length by 1.25×; the crop is shown by a frame in the display.
OFF	The 1.25× crop is disabled.

- The **IMAGE QUALITY SETTING** > **IMAGE SIZE** item in the shooting menu is fixed at **M**.
- The sports finder is not available in modes that offer an electronic shutter.

PRE-SHOT ES



To reduce the lag between your pressing the shutter button all the way down and the resulting picture being recorded to the memory card, the camera starts shooting with the electronic shutter when the shutter button is pressed halfway and saves a series shots starting just before the shutter button is pressed the rest of the way down.

Options	
ON	OFF

- Pre-shot photography is available only when **ES ELECTRONIC SHUTTER** is selected in **CH** (high speed burst) drive mode (144).

SELF-TIMER

Choose a shutter release delay.

Option	Description
 2 SEC	The shutter is released two seconds after the shutter button is pressed. Use to reduce blur caused by the camera moving when the shutter button is pressed. The self-timer lamp blinks as the timer counts down.
 10 SEC	The shutter is released ten seconds after the shutter button is pressed. Use for photographs in which you wish to appear yourself. The self-timer lamp blinks immediately before the picture is taken.
OFF	Self-timer off.

If an option other than **OFF** is selected, the timer will start when the shutter button is pressed all the way down. The display shows the number of seconds remaining until the shutter is released. To stop the timer before the picture is taken, press **DISP/BACK**.



-  Stand behind the camera when using the shutter button. Standing in front of the lens can interfere with focus and exposure.
- The self-timer turns off automatically when the camera is turned off.

SAVE SELF-TIMER SETTING

If **ON** is selected, the chosen self-timer setting will remain in effect after a picture is taken or the camera is turned off.

Options	
ON	OFF

SELF-TIMER LAMP

If **ON** is selected, the self-timer lamp will light during self-timer photography. Select **OFF** when shooting night scenes or in other situations in which you would prefer that the lamp remain unlit.

Options	
ON	OFF

INTERVAL TIMER SHOOTING

Configure the camera to take photos automatically at a preset interval.

- 1 Select **SHOOTING SETTING** in the shooting menu, highlight **INTERVAL TIMER SHOOTING**, and press **MENU/OK**.

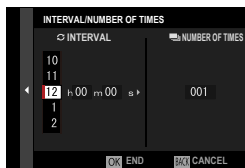

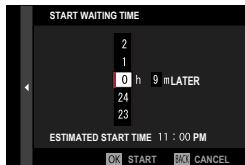

- 2 Use the focus stick (focus lever) to choose the interval and number of shots. Press **MENU/OK** to proceed.

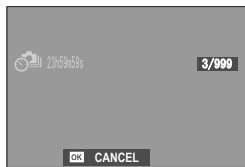

- 3 Use the focus stick to choose the starting time and then press **MENU/OK**. Shooting will start automatically.



 Interval timer photography cannot be used at a shutter speed of **B** (bulb) or with multiple exposure photography. In burst mode, only one picture will be taken each time the shutter is released.

-  • Use of a tripod is recommended.
- Check the battery level before starting. We recommend using USB power source (📖 238).
- The display turns off between shots and lights a few seconds before the next shot is taken.
- The display can be activated at any time by pressing the shutter button.
- To continue shooting until the number of shots taken equals the number of exposures remaining at the time interval-timer photography started, set the number of shots to ∞.

INTERVAL TIMER SHOOTING EXPOSURE SMOOTHING

Select **ON** to automatically adjust exposure during interval-timer photography to prevent it changing dramatically between shots.

Options	
ON	OFF

-  • Large changes in subject brightness may make exposure appear erratic. We recommend that you choose shorter values for **INTERVAL TIMER SHOOTING** > **INTERVAL** with subjects that brighten or dim dramatically during shooting.
- In manual mode (mode **M**), exposure smoothing is only available if an AUTO option is selected for sensitivity.

AE BKT SETTING

Adjust exposure bracketing settings.

Option	Description
FRAMES/STEP SETTING	Choose the number of shots in the bracketing sequence and the amount exposure is varied with each shot. <ul style="list-style-type: none">• FRAMES: Choose the number of shots in the bracketing sequence.• STEP: Choose the amount exposure is varied with each shot.
1 FRAME/CONTINUOUS	<ul style="list-style-type: none">• 1 FRAME: The shots in the bracketing sequence are taken one at a time.• CONTINUOUS: The shots in the bracketing sequence are taken in a single burst.
SEQUENCE SETTING	Choose the order in which the shots are taken.

FILM SIMULATION BKT

Choose the three film simulation types used for film simulation bracketing (📖 108).

FOCUS BKT SETTING

Choose from **AUTO** and **MANUAL** focus bracketing modes (📖 91).

PHOTOMETRY

Choose how the camera meters exposure (📖 85).

SHUTTER TYPE

Choose the shutter type. Choose the electronic shutter to mute the shutter sound.

Option	Description
MS MECHANICAL SHUTTER	Take pictures with the mechanical shutter.
ES ELECTRONIC SHUTTER	Take pictures with the electronic shutter.
M+E MECHANICAL + ELECTRONIC	The camera chooses the mechanical or electronic shutter according to shooting conditions.



When using the electronic shutter, note the following:

- Distortion may be visible in shots of moving subjects.
- Distortion may also be visible in hand-held shots taken at high shutter speeds; use of a tripod is recommended.
- Banding and fog may occur in shots taken under fluorescent lights or other flickering or erratic illumination.
- When taking pictures with the shutter muted (📖 212), respect your subjects' image rights and right to privacy.



The following restrictions apply when the electronic shutter is used:

- "Extended" sensitivity values are not supported
- Long exposure noise reduction has no effect
- The flash cannot be used

FLICKER REDUCTION





Reduce flicker in pictures and the display when shooting under fluorescent lighting and other similar light sources.

Option	Description
ALL FRAMES	Flicker reduction is performed for all frames. Compared to when flicker reduction is performed only on the first frame, the frame advance rate for burst photography will drop.
FIRST FRAME	Flicker reduction is performed for the first frame only; in burst photography, the value measured for the first frame in each burst will be used for all subsequent shots. Flicker may be visible during burst photography.
OFF	Flicker reduction disabled.

-  • Flicker reduction increases the time needed to record pictures.
- **OFF** is selected for **FLICKER REDUCTION** when the electronic shutter is used.
- Flicker reduction is not available during movie recording.

IS MODE

Reduce blur caused by camera shake or subject motion.

Option	Description
 CONTINUOUS + MOTION	Image stabilization on. If + MOTION is selected, the camera will adjust shutter speed to reduce motion blur when moving objects are detected.
 CONTINUOUS	
 SHOOTING + MOTION	As above, except that image stabilization is performed only when the shutter button is pressed halfway (focus mode  only) or the shutter is released. If + MOTION is selected, the camera will adjust shutter speed to reduce motion blur when moving objects are detected.
 SHOOTING ONLY	
OFF	Image stabilization off. Choose this option when using a tripod.

 **+ MOTION** has no effect when sensitivity is set to a fixed value, and may also be unavailable at some other combinations of settings. The effect may vary with lighting conditions and the speed at which the object is moving.

ISO

Adjust the camera's sensitivity to light ( 83).

WIRELESS COMMUNICATION

Connect to smartphones running the latest version of the FUJIFILM Camera Remote app. The smartphone can then be used to:

- Control the camera and take pictures remotely
- Receive pictures uploaded from the camera
- Browse the pictures on the camera and download selected pictures
- Upload location data to the camera



For downloads and other information, visit:

http://app.fujifilm-dsc.com/en/camera_remote/

FLASH SETTING (Still Photography)

Adjust flash-related settings for still photography.

To display flash settings, press **MENU/OK** in the photo shooting display and select the **⚡** (FLASH SETTING) tab.

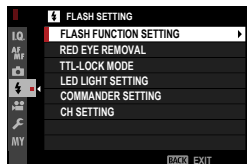

FLASH FUNCTION SETTING

Choose a flash control mode, flash mode, or sync mode or adjust the flash level. The options available vary with the flash.

 For more information on flash settings, see “External Flash Units” (📖 264) in “Peripherals and Optional Accessories”.

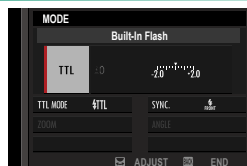

RED EYE REMOVAL

Remove red-eye effects caused by the flash.

Option	Description
FLASH+REMOVAL	A red-eye reduction pre-flash is combined with digital red-eye removal.
FLASH	Flash red-eye reduction only.
REMOVAL	Digital red-eye removal only.
OFF	Flash red-eye reduction and digital red-eye removal off.

-  • Flash red-eye reduction can be used in TTL flash control mode.
- Digital red-eye removal is performed only when a face is detected.
 - Digital red-eye removal is not available with RAW images.

TTL-LOCK MODE

Instead of adjusting flash level with each shot, TTL flash control can be locked for consistent results across a series of photographs.

Option	Description
LOCK WITH LAST FLASH	Flash output is locked at the value metered for the most recent photo.
LOCK WITH METERING FLASH	The camera emits a series of pre-flashes and locks flash output at the metered value.

- To use TTL lock, assign **TTL-LOCK** to a camera control and then use the control to enable or disable TTL lock (📖 251).
- Flash compensation can be adjusted while TTL lock is in effect.
- Selecting **LOCK WITH LAST FLASH** displays an error message if no previously metered value exists.

LED LIGHT SETTING

Choose whether to use the flash unit's LED video light (if available) as a catchlight or AF-assist illuminator when taking photos.

Option	Role of LED video light in still photography
CATCHLIGHT	Catchlight
AF ASSIST	AF-assist illuminator
AF ASSIST+CATCHLIGHT	AF-assist illuminator and catchlight
OFF	None

- In some cases, this option can also be accessed via the **FLASH FUNCTION SETTING** menu.

COMMANDER SETTING

Choose groups when using the camera flash unit as a commander for Fujifilm optical wireless remote flash control. This option is available when the camera is used with clip-on flash units that support Fujifilm optical wireless flash control.

Options			
Gr A	Gr B	Gr C	OFF



In some cases, this option can also be accessed via the **FLASH FUNCTION SETTING** menu.

CH SETTING

Choose the channel used for communication between the commander and remote flash units. Separate channels can be used for different flash systems or to prevent interference when multiple systems are operating in close proximity.

Options			
CH1	CH2	CH3	CH4

MOVIE SETTING (Still Photography)

Adjust options for movies shot during still photography using the  (movie recording) button.

To display movie settings, press **MENU/OK** in the photo shooting display and select the  (**MOVIE SETTING**) tab.

 The options available vary with the shooting mode selected.

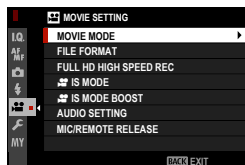

MOVIE MODE

This item is also found in the movie menu ( 154). Changes here also apply to the item in the movie menu.

FILE FORMAT

This item is also found in the movie menu ( 155). Changes here also apply to the item in the movie menu.

FULL HD HIGH SPEED REC

This item is also found in the movie menu ( 156). Changes here also apply to the item in the movie menu.

IS MODE

This item is also found in the movie menu ( 160). Changes here also apply to the item in the movie menu.

IS MODE BOOST

This item is also found in the movie menu ( 160). Changes here also apply to the item in the movie menu.

AUDIO SETTING

Adjust audio-related settings for movie recording.

INTERNAL MIC LEVEL ADJUSTMENT

Adjust the recording level for the built-in microphone.

Option	Description
AUTO	The camera adjusts the recording level automatically.
MANUAL	Adjust the recording level manually. Press the focus stick (focus lever) right to choose from 25 recording levels.
OFF	Turn the built-in microphone off.

EXTERNAL MIC LEVEL ADJUSTMENT

Adjust the recording level for external microphones.

Option	Description
AUTO	The camera adjusts the recording level automatically.
MANUAL	Adjust the recording level manually. Press the focus stick (focus lever) right to choose from 25 recording levels.
OFF	Disable recording using external microphones.

MIC JACK SETTING

Specify the type of hardware connected to the microphone jack.

Option	Description
MIC	Choose this option for direct connection to an external microphone.
LINE	Choose this option for external audio devices connected via line output.

MIC LEVEL LIMITER

Reduces distortion caused by input that exceeds the limits of the microphone's audio circuits.

Options	
ON	OFF

WIND FILTER

Choose whether to enable wind noise reduction during movie recording.

Options	
ON	OFF

LOW CUT FILTER

Choose whether to enable the low-cut filter, reducing low-frequency noise during movie recording.

Options	
ON	OFF

HEADPHONES VOLUME

Adjust the headphone volume.

Option	Description
0	Mute output to the headphones.
1—10	Choose a volume of from 1 to 10.

MIC/REMOTE RELEASE

Specify whether the device connected to the microphone/remote release connector is a microphone or a remote release.

Options	
 MIC	 REMOTE

MOVIE SETTING (Movie Recording)

Adjust options for movies shot with the mode dial rotated to  (movie).

To display options for movie recording, press **MENU/OK** in the movie shooting display and select the  (**MOVIE SETTING**) tab.

 The options available vary with the shooting mode selected.

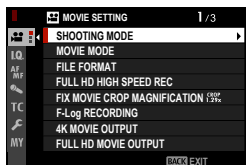

SHOOTING MODE

Choose a shooting mode for movies.

Options			
PROGRAM AE	SHUTTER PRIORITY AE	APERTURE PRIORITY AE	MANUAL

MOVIE MODE

Before shooting movies, choose the frame rate, bit rate, and frame size and aspect ratio.

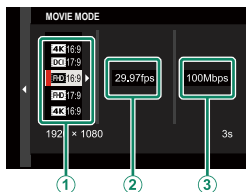

- 1 In the shooting menu, select  **MOVIE SETTING**, then highlight **MOVIE MODE** and press **MENU/OK**.

- Press the focus stick (focus lever) up or down to highlight the desired frame size and aspect ratio (①) and press the stick right.
 - Choose **4K 16:9** or **DGI 17:9** for 4K movies with aspect ratios of 16 or 17 to 9.
 - Choose **FHD 16:9** or **FHD 17:9** for Full HD movies with aspect ratios of 16 or 17 to 9.
- Press the focus stick (focus lever) up or down to highlight a frame rate (②) and press the stick right.

Options					
23.98P	24P	25P	29.97P	50P	59.94P

- Press the focus stick up or down to highlight a bit rate (③) and press **MENU/OK**.

Options		
50Mbps	100Mbps	200Mbps

 The choice of frame and bit rates varies with the movie mode.

FILE FORMAT

Choose a movie format.

Option	Description
MOV/H.264 LPCM	High picture and sound quality.
MP4/H.264 AAC	A format suitable for movies that will be uploaded to the web.

 Movies are recorded to the memory card in 8-bit 4:2:0 and output to HDMI in 10-bit 4:2:2.

FULL HD HIGH SPEED REC

Record high-frame-rate Full HD movies. High-frame-rate movies can be played back in slow motion, giving you time to view fast-moving subjects or details too fleeting for the naked eye. Select **ON** to choose the recording and playback rates separately.

Playback

Options					
23.98P	24P	25P	29.97P	50P	59.94P

Recording

Options			
100P	120P	200P	240P



- High-speed movies are recorded with no sound.
- Maximum recording length is 6 minutes, but varies with camera settings.
- The footage recorded to the memory card is compressed with the goal of keeping the amount of data recorded to 200 Mbps per second.
- The options available for playback rate vary with the option selected for rate of recording.

FIX MOVIE CROP MAGNIFICATION CROP
1.29x

Fix the movie crop ratio at 1.29:1. This makes it easier to match crops when filming in different formats.





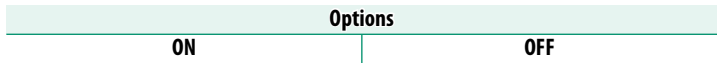



**F-Log RECORDING**

Select **ON** to record movies using a soft gamma curve with a wide gamut suitable for further processing post-production. Sensitivity is restricted to values between ISO 640 and 12800.



4K MOVIE OUTPUT





Choose the destination for 4K movies shot while the camera is connected to an HDMI recorder or other device that supports 4K.

Option	Description
 SD 4K  HDMI 4K	4K movies are recorded to the camera memory card and output to the HDMI device in 4K.
 SD 4K  HDMI FHD	4K movies are recorded to a camera memory card in 4K and output to the HDMI device in Full HD.
 SD FHD  HDMI 4K	4K movies are output to the HDMI device in 4K and recorded to the camera memory card in Full HD.
 SD -  HDMI 4K	4K movies are output to the HDMI device in 4K. The camera does not record 4K movies to a memory card.

 This option is only available when **4K: 16:9** or **DCI: 17:9** is selected for **MOVIE SETTING > MOVIE MODE** in the shooting menu.

FULL HD MOVIE OUTPUT

Choose the destination for Full HD movies shot while the camera is connected to an HDMI device.

Option	Description
 SD FHD  HDMI FHD	Full HD movies are output to the HDMI device and recorded to the camera memory card.
 SD -  HDMI FHD	Full HD movies are not recorded to the camera memory card but are output to the HDMI device.

 • This option is only available when **FHD: 16:9** or **FHD: 17:9** is selected for **MOVIE SETTING > MOVIE MODE** in the shooting menu.

• When **OFF** is selected for **HDMI OUTPUT INFO DISPLAY**, movies will be output to the HDMI device in 4:2:2 10-bit format.

HDMI OUTPUT INFO DISPLAY

If **ON** is selected, HDMI devices to which the camera is connected will mirror the information in the camera display.

Options	
ON	OFF

4K HDMI STANDBY QUALITY

Choose whether output to connected HDMI devices switches from 4K to Full HD during standby.

Option	Description
4K	Output to HDMI devices continues at 4K during standby.
FHD	Output to HDMI devices switches to Full HD during standby, reducing the drain on the battery.



HDMI REC CONTROL

Choose whether the camera sends movie start and stop signals to the HDMI device when the shutter button is pressed to start and stop movie recording.

Options	
ON	OFF

PHOTOMETRY

Options are the same as those for still photography, but settings must be adjusted separately ( 143).

 The photometry option selected in the photo menus applies to movies recorded using the  (movie recording) button.

IS MODE

Reduce blur.



Option	Description
IBIS/OIS	Enable in-body (IBIS) and optical (OIS) image stabilization. IBIS is used with lenses that do not support OIS.
IBIS/OIS + DIS	Enable in-body (IBIS), optical (OIS), and digital (DIS) image stabilization. The crop is adjusted according to the option selected for MOVIE MODE .
OFF	Image stabilization off;  appears in the display. Choose when the camera is mounted on a tripod or otherwise fixed in place.

-  The setting selected with the lens image stabilization switch, if any, takes priority over the setting chosen with the IS mode.
- Note that vibration or camera sounds may be noticeable as image stabilization takes effect.
- IBIS/OIS + DIS** is not available when high-speed Full HD recording is enabled.

IS MODE BOOST

Choose the image stabilization level.

Option	Description
ON	Suitable for hand-held shooting with no panning.
OFF	Suitable for hand-held shooting with panning.

-  Assigning **IS MODE BOOST** to a function button allows the image stabilization level to be changed while recording is in progress ( 251).



 **ISO**

Adjust the camera's sensitivity to light.

Option	Description
H (25600)	Choose for special situations. Note that dynamic range may be reduced and that pictures may be mottled.
160–12800	Adjust sensitivity manually. Selected value is shown in display.
AUTO	Sensitivity is automatically adjusted in response to shooting conditions.

ZEBRA SETTING

Highlights that may be overexposed are shown by zebra stripes in the movie mode display.

Option	Description
ZEBRA RIGHT	 Right-slanting stripes.
ZEBRA LEFT	 Left-slanting stripes.
OFF	Stripes off.

ZEBRA LEVEL

Choose the brightness threshold for the zebra stripe display.

Options										
50	55	60	65	70	75	80	85	90	95	100

MOVIE OPTIMIZED CONTROL 

Select **ON** to allow movie settings to be adjusted using only the command dials and touch-screen controls. You may find this helpful in preventing the sounds of camera controls being recorded with movies (📖 23).

Options	
ON	OFF

TALLY LIGHT



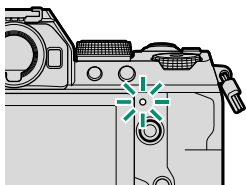



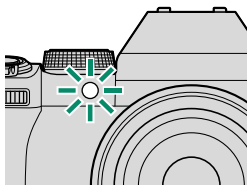

Choose the lamp (indicator or AF-assist) that lights during movie recording and whether the lamp blinks or remains steady.



Indicator lamp



AF-assist illuminator

Option	Description
FRONT OFF REAR 	The indicator lamp lights during movie recording.
FRONT OFF REAR 	The indicator lamp blinks during movie recording.
FRONT  REAR 	The indicator and AF-assist lamps light during movie recording.
FRONT  REAR OFF	The AF-assist lamp lights during movie recording.
FRONT  REAR 	The indicator and AF-assist lamps blink during movie recording.
FRONT  REAR OFF	The AF-assist lamp blinks during movie recording.
FRONT OFF REAR OFF	The indicator and AF-assist lamps remain off during movie recording.

WIRELESS COMMUNICATION



This item is also found in the photo menus ( 147).

IMAGE QUALITY SETTING (Movie Recording)

Adjust image quality settings for movies.

To display image quality settings, press **MENU/OK** in the movie shooting display and select the **IQ** (IMAGE QUALITY SETTING) tab.

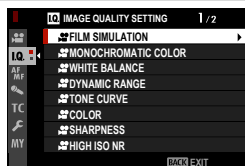

 The options available vary with the shooting mode selected.

FILM SIMULATION

Options are the same as those for still photography, but settings must be adjusted separately ( 108).

MONOCHROMATIC COLOR



Options are the same as those for still photography, but settings must be adjusted separately ( 110).

WHITE BALANCE

Options are the same as those for still photography, but settings must be adjusted separately ( 111).

DYNAMIC RANGE

Choose a dynamic range for movie recording.

Option	Description
 100%	See “DYNAMIC RANGE” (📖 115).
 200%	
 400%	

-  **AUTO** (automatic dynamic range control) is not available during movie recording.
-  **200%** is available at sensitivities of from ISO 320 to ISO 12800,  **400%** at sensitivities of from ISO 640 to 12800.
- The  **MOVIE SETTING** >  **DYNAMIC RANGE** option is available when **OFF** is selected for  **MOVIE SETTING** > **F-Log RECORDING**.

TONE CURVE

Options are the same as those for still photography, but settings must be adjusted separately (📖 116).

COLOR

Options are the same as those for still photography, but settings must be adjusted separately (📖 117).

SHARPNESS

Options are the same as those for still photography, but settings must be adjusted separately ( 117).

HIGH ISO NR

Options are the same as those for still photography, but settings must be adjusted separately ( 117).

INTERFRAME NR





Select **ON** to enable interframe noise reduction.

Options	
ON	OFF

-  Interframe noise reduction is available only when frame rates of **29.97P** or slower are selected at a frame size of **4K** or **DCI**.
- "Ghosting" may occur with moving subjects or if the camera is moved during shooting.

PERIPHERAL LIGHT CORRECTION

Select **ON** to enable peripheral illumination correction during movie recording.

Options	
ON	OFF
 <ul style="list-style-type: none"> If ON is selected when a lens that does not transmit data to the camera is attached using a FUJIFILM M MOUNT ADAPTER (available separately), peripheral illumination will be adjusted according to the option selected for  IMAGE QUALITY SETTING >   MOUNT ADAPTER SETTING > PERIPHERAL ILLUMINATION CORRECTION in the shooting menu (📖 121). Select OFF if you notice banding in movies recorded using this option. 	

MOUNT ADAPTER SETTING

This item is also found in the photo menus (📖 120). Changes to one apply to the other.

AF/MF SETTING (Movie Recording)

Adjust focus settings for movies.

To display AF/MF settings, press **MENU/OK** in the movie shooting display and select the **AF/MF** (AF/MF SETTING) tab.

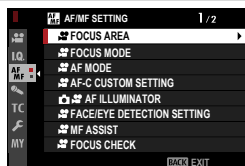



 The options available vary with the shooting mode selected.

FOCUS AREA

Options are the same as those for still photography, but settings must be adjusted separately ( 122).

FOCUS MODE

Choose the focus mode for movie recording.

Option	Description
 MANUAL FOCUS	Focus manually.
 CONTINUOUS AF	The camera focuses using AF-C.
 SINGLE AF	The camera focuses using AF-S.

AF MODE

Choose how the camera selects the focus point for movie recording.

Option	Description
MULTI	The camera selects the focus area automatically.
AREA	The camera focuses on the subject in the selected focus area.

AF-C CUSTOM SETTING

Select focus-tracking options when recording movies with **CONTINUOUS AF** selected for  **FOCUS MODE**.

TRACKING SENSITIVITY

Choose how long the camera waits to switch focus when an object enters the focus area behind or in front of the current subject. See “TRACKING SENSITIVITY” ( 124).

Options				
0	1	2	3	4

-  • The higher the value, the longer it takes the camera to refocus when you attempt to switch subjects.
- The lower the value, the more likely the camera is to switch focus from your subject to other objects in the focus area.

AF SPEED

Adjust the autofocus response speed. Choose higher values for faster response times, lower values for slower response times.

Options										
-5	-4	-3	-2	-1	0	+1	+2	+3	+4	+5

AF ILLUMINATOR

This item is also found in the photo menus ( 128). Changes to one apply to the other.

FACE/EYE DETECTION SETTING

Enable or disable Intelligent Face Detection when recording movies.

Option	Description
FACE DETECTION ON	See "FACE/EYE DETECTION SETTING" (📖 129).
OFF	Intelligent Face Detection and eye priority off.

 If **SINGLE AF** is chosen for **FOCUS MODE** when **FACE DETECTION ON** is selected for **AF/MF SETTING > FACE/EYE DETECTION SETTING**, the camera will automatically switch to **CONTINUOUS AF**. Selecting **MANUAL FOCUS** when **FACE DETECTION ON** is selected for **FACE/EYE DETECTION SETTING** disables Intelligent Face Detection.

MF ASSIST

Choose how focus is displayed when **MANUAL FOCUS** is selected for **FOCUS MODE**.

Option	Description
STANDARD	Focus is displayed normally (focus peaking is not available).
FOCUS PEAK HIGHLIGHT	The camera heightens high-contrast outlines. Choose a color and peaking level.

FOCUS CHECK

Options are the same as those for still photography, but settings must be adjusted separately ( 132).

INSTANT AF SETTING

This item is also found in the photo menus ( 133). Changes to one apply to the other.

DEPTH-OF-FIELD SCALE





This item is also found in the photo menus ( 133). Changes to one apply to the other.

AF RANGE LIMITER

This item is also found in the photo menus ( 134). Changes to one apply to the other.

TOUCH SCREEN MODE

Choose the shooting operations performed using touch controls.

Mode	Description
 TOUCH SHOOTING	<p>Instead of pressing the shutter button, you can tap your subject in the display to focus and start recording. During recording, you can tap the display to focus as described below. <i>To end recording, press the shutter button.</i></p>
 AF	<p>Tapping the display focuses the camera on the selected point. <i>Use the shutter button to start and stop recording.</i></p> <ul style="list-style-type: none"> • When SINGLE AF is selected for FOCUS MODE, you can refocus at any time by tapping your subject in the display. • When CONTINUOUS AF is chosen for FOCUS MODE, the camera will continuously adjust focus for changes in the distance to the subject at point selected by tapping the display. • When MANUAL FOCUS is selected for FOCUS MODE, the camera will focus using autofocus if you tap the display before recording begins; during recording, you can tap the display again to move the focus area to a new location.
 AREA	<p>Tap to position the focus area. <i>Use the shutter button to start and stop recording.</i></p> <ul style="list-style-type: none"> • When SINGLE AF is selected for FOCUS MODE, you can reposition the focus area at any time by tapping your subject in the display. To focus, use the button to which AF-ON is assigned. • When CONTINUOUS AF is chosen for FOCUS MODE, the camera will continuously adjust focus for changes in the distance to the subject at point selected by tapping the display. • When MANUAL FOCUS is selected for FOCUS MODE, you can tap the display to position the focus area over your subject.
 OFF	<p>Touch controls disabled.</p>



- To disable touch controls and hide the touch screen mode indicator, select **OFF** for **☑️ BUTTON/DIAL SETTING > TOUCH SCREEN SETTING > 📷 TOUCH SCREEN SETTING**.
- This item is also found in the photo menu (📖 135). Changes to one apply to the other.

Touch Controls for Focus Zoom

Different touch controls are used during focus zoom (focus check enabled).

Central Area

Tapping the center of the display performs the operations below.

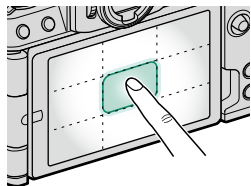

Mode	Operation performed
TOUCH SHOOTING	SINGLE AF: AF
	MANUAL FOCUS: Instant AF
AF	SINGLE AF: AF
	MANUAL FOCUS: Instant AF
AREA	SINGLE AF: AF
	MANUAL FOCUS: Instant AF
OFF	SINGLE AF/MANUAL FOCUS: OFF

Other Areas

Tapping other areas simply scrolls the display, whether during still photography or movie recording and regardless of the option selected for touch screen mode.

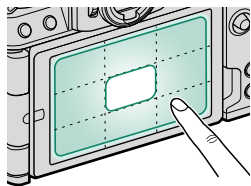

FOCUS CHECK LOCK

Choose whether focus zoom remains in effect once movie recording begins.

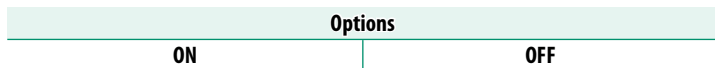

AUDIO SETTING (Movie Recording)

Adjust settings for audio recorded during filming.

To display audio settings, press **MENU/OK** in the movie shooting display and select the  (**AUDIO SETTING**) tab.

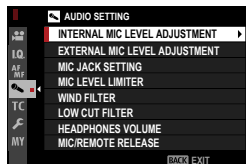

INTERNAL MIC LEVEL ADJUSTMENT

Adjust the recording level for the built-in microphone.

Option	Description
AUTO	The camera adjusts the recording level automatically.
MANUAL	Adjust the recording level manually. Press the focus stick (focus lever) right to choose from 25 recording levels.
OFF	Turn the built-in microphone off.

EXTERNAL MIC LEVEL ADJUSTMENT

Adjust the recording level for external microphones.

Option	Description
AUTO	The camera adjusts the recording level automatically.
MANUAL	Adjust the recording level manually. Press the focus stick (focus lever) right to choose from 25 recording levels.
OFF	Disable recording using external microphones.

MIC JACK SETTING

Specify the type of hardware connected to the microphone jack.

Option	Description
MIC	Choose this option for direct connection to an external microphone.
LINE	Choose this option for external audio devices connected via line output.

MIC LEVEL LIMITER

Reduces distortion caused by input that exceeds the limits of the microphone's audio circuits.

Options	
ON	OFF

WIND FILTER

Choose whether to enable wind noise reduction during movie recording.

Options	
ON	OFF

LOW CUT FILTER

Choose whether to enable the low-cut filter, reducing low-frequency noise during movie recording.

Options	
ON	OFF



HEADPHONES VOLUME

Adjust the headphone volume.

Option	Description
0	Mute output to the headphones.
1—10	Choose a volume of from 1 to 10.

MIC/REMOTE RELEASE

Specify whether the device connected to the microphone/remote release connector is a microphone or a remote release.

Options	
 MIC	 REMOTE

TIME CODE SETTING (Movie Recording)

Adjust time code (hour, minute, second, and frame number) display settings for movie recording.

To display time code settings, press **MENU/OK** in the movie shooting display and select the **TC** (TIME CODE SETTING) tab.

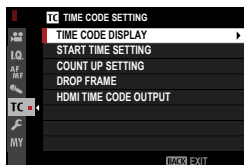

TIME CODE DISPLAY

Select **ON** to display time codes during movie recording and playback.

Options	
ON	OFF

START TIME SETTING

Choose the time code starting time.

Option	Description
MANUAL INPUT	Highlight this option and press the focus stick (focus lever) right to choose a start time manually.
CURRENT TIME	Set the start time to the current time.
RESET	Set the start time to 00:00:00.

COUNT UP SETTING

Choose whether time is clocked continuously or only during movie recording.

Option	Description
REC RUN	Time is clocked only during movie recording.
FREE RUN	Time is clocked continuously.

DROP FRAME

At frame rates of **59.94P**, and **29.97P**, a discrepancy will gradually develop between the time code (measured in seconds) and the actual recording time (measured in fractions of a second). Choose whether the camera drops frames as necessary to match the recording time to the time code.

Option	Description
ON	The camera drops frames as necessary to maintain a strict match between the time code and the actual recording time.
OFF	Frames are not dropped.



- The time code display varies with the option selected.

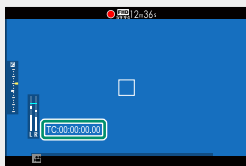

TC:00:00:00.00

ON

TC:00:00:00.00

OFF

- Selecting a frame rate of **23.98P** disables frame drop.

HDMI TIME CODE OUTPUT

Choose whether time codes are output to HDMI devices.

Options	
ON	OFF

Playback and the Playback Menu

7

The Playback Display

This section lists the indicators that may be displayed during playback.

i For illustrative purposes, displays are shown with all indicators lit.

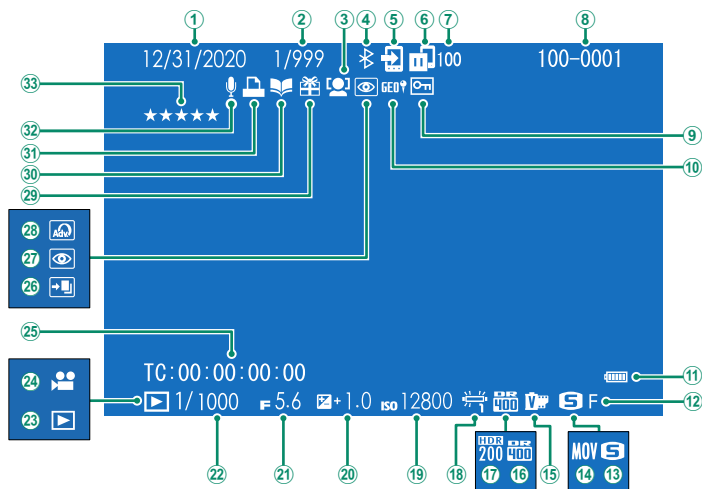

① Date and time.....	37, 39, 207	⑱ White balance	111
② Frame-number display		⑲ Sensitivity	83
③ Face detection indicator	129	⑳ Exposure compensation	82
④ Bluetooth ON/OFF.....	234	㉑ Aperture.....	57, 60, 62
⑤ Image transfer order.....	197	㉒ Shutter speed	57, 58, 62
⑥ Image transfer status	234, 278	㉓ Playback mode indicator	44
⑦ Number of frames selected for upload ...	197	㉔ Movie icon	52
⑧ Frame number.....	231	㉕ Time code.....	177
⑨ Protected image.....	192	㉖ HDR image	94
⑩ Location data.....	239, 279	㉗ Red-eye removal indicator.....	148, 194
⑪ Battery level.....	36	㉘ Filter	66
⑫ Image quality.....	107	㉙ Gift image	44
⑬ Image size.....	106	㉚ Photobook assist indicator	199
⑭ Film format.....	155	㉛ DPOF print indicator.....	201
⑮ Film simulation	108	㉜ Voice memo	195
⑯ Dynamic range	115	㉝ Rating.....	196
⑰ HDR.....	94		

The DISP/BACK Button

The **DISP/BACK** button controls the display of indicators during playback.

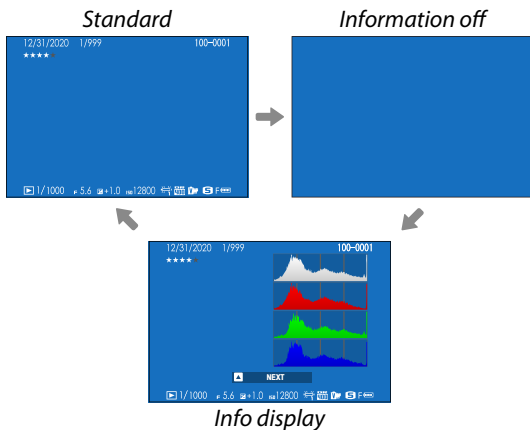
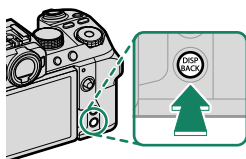

Viewing Photo Information

The photo information display changes each time the focus stick (focus lever) is pressed up.

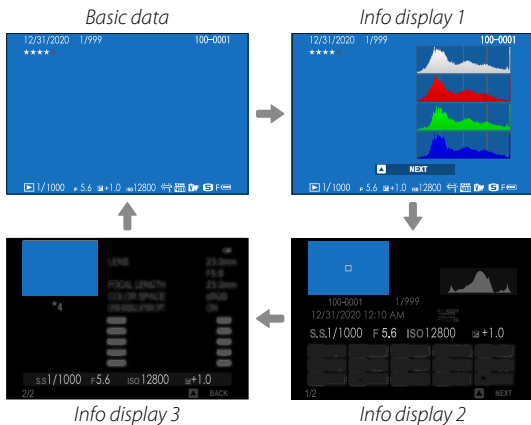
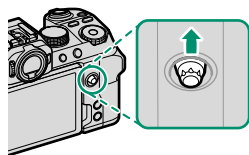

Zooming in on the Focus Point

Press the center of the focus stick (focus lever) to zoom in on the focus point. Press again to return to full-frame playback.



Viewing Pictures

Read this section for information on playback zoom and multi-frame playback.

Use the rear command dial to go from full-frame playback to playback zoom or multi-frame playback.

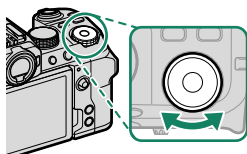

Full-frame playback



Multi-frame playback



Nine-frame view



Hundred-frame view

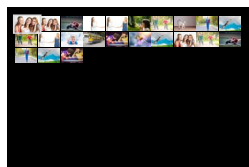

Playback zoom



Medium zoom

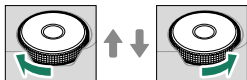
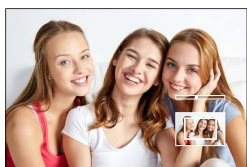

Maximum zoom



Playback Zoom

Rotate the rear command dial right to zoom in on the current picture, left to zoom out. To exit zoom, press **DISP/BACK** or **MENU/OK**.

- The maximum zoom ratio varies with the option selected for **IMAGE QUALITY SETTING > IMAGE SIZE**.
 - Playback zoom is not available with cropped or resized copies saved at a size of **640**.

Scroll

When the picture is zoomed in, the focus stick (focus lever) can be used to view areas of the image not currently visible in the display.



Navigation window

Multi-Frame Playback

To change the number of images displayed, rotate the rear command dial left when a picture is displayed full frame.

- Use the focus stick (focus lever) to highlight images and press **MENU/OK** to view the highlighted image full frame.
- In the nine- and hundred-frame displays, press the focus stick up or down to view more pictures.

The Playback Menu

Adjust playback settings.

The playback menu is displayed when you press **MENU/OK** in playback mode.

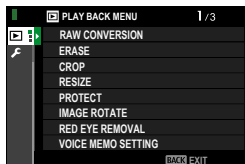

RAW CONVERSION

Even if you don't have a computer, you can use the camera to modify RAW pictures and save them in other formats.

Saving RAW Pictures in Another Format

- 1 Display a RAW picture.
- 2 Highlight **RAW CONVERSION** in the playback menu.
- 3 Press **MENU/OK**.
A list of settings will be displayed.

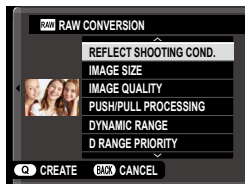

- 4 Press the focus stick (focus lever) up or down to highlight a setting.
- 5 Press the focus stick right to display options.

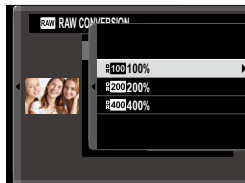

- 6 Press the focus stick up or down to highlight the desired option.
- 7 Press **MENU/OK** to select the highlighted option. The settings list shown in Step 3 will be displayed. Repeat Steps 4 to 7 to adjust additional settings.
- 8 Press the **Q** button.
A preview of the copy will be displayed.
- 9 Press **MENU/OK**.
The copy will be saved.



RAW conversion options can also be displayed by pressing the **Q** button when a RAW picture is displayed during playback.

The settings that can be adjusted when converting pictures from RAW to another format are:

Setting	Description
REFLECT SHOOTING COND.	Create a copy using the settings in effect at the time the photo was taken.
IMAGE SIZE	Choose an image size.
IMAGE QUALITY	Adjust image quality.
PUSH/PULL PROCESSING	Adjust exposure.
DYNAMIC RANGE	Enhance details in highlights for natural contrast.
D RANGE PRIORITY	Reduce loss of detail in highlights and shadows for natural-looking results when photographing high-contrast scenes.
FILM SIMULATION	Simulate the effects of different types of film.
MONOCHROMATIC COLOR	Add a warm or cool cast to monochrome pictures.
GRAIN EFFECT	Add a film grain effect.
COLOR CHROME EFFECT	Increase the range of tones available for rendering colors that tend to be highly saturated, such as reds, yellows, and greens.
COLOR CHROME FX BLUE	Increase the range of tones available for rendering blues.
WHITE BALANCE	Adjust white balance.
WB SHIFT	Fine-tune white balance.
TONE CURVE	Adjust highlights and shadows.
COLOR	Adjust color density.
SHARPNESS	Sharpen or soften outlines.
HIGH ISO NR	Process the copy to reduce mottling.
CLARITY	Increase definition.
LENS MODULATION OPTIMIZER	Improve definition by adjusting for diffraction and the slight loss of focus at the periphery of the lens.
COLOR SPACE	Choose the color space used for color reproduction.
HDR MODE	Reduce loss of detail in highlights and shadows.

 Some settings may be unavailable depending on the options chosen when the picture was taken.

ERASE

Delete individual pictures, multiple selected pictures, or all pictures.

 Deleted pictures cannot be recovered. Protect important pictures or copy them to a computer or other storage device before proceeding.

Option	Description
FRAME	Delete pictures one at a time.
SELECTED FRAMES	Delete multiple selected pictures.
ALL FRAMES	Delete all unprotected pictures.

FRAME

- 1 Select **FRAME** for **ERASE** in the playback menu.
- 2 Press the focus stick (focus lever) left or right to scroll through pictures and press **MENU/OK** to delete.

 • A confirmation dialog is not displayed before pictures are deleted; be sure the correct picture is selected before pressing **MENU/OK**.

• Additional pictures can be deleted by pressing **MENU/OK**. Press the focus stick left or right to scroll through pictures and press **MENU/OK** to delete.

SELECTED FRAMES

- 1 Select **SELECTED FRAMES** for **ERASE** in the playback menu.
- 2 Highlight pictures and press **MENU/OK** to select.
 - Selected pictures are indicated by check marks (☑).
 - To deselect a highlighted picture, press **MENU/OK** again.
- 3 When the operation is complete, press **DISP/BACK** to display a confirmation dialog.
- 4 Highlight **OK** and press **MENU/OK** to delete the selected pictures.



Pictures in photobooks or printer orders are shown by .

ALL FRAMES

- 1 Select **ALL FRAMES** for **ERASE** in the playback menu.
- 2 A confirmation dialog will be displayed; highlight **OK** and press **MENU/OK** to delete all unprotected pictures.



- Pressing **DISP/BACK** cancels deletion; note that any pictures deleted before the button was pressed cannot be recovered.
- If a message appears stating that the selected images are part of a DPOF print order, press **MENU/OK** to delete the pictures.

CROP

Create a cropped copy of the current picture.

- 1 Display the desired picture.
- 2 Select **CROP** in the playback menu.
- 3 Use the rear command dial to zoom in and out and press the focus stick (focus lever) up, down, left, or right to scroll the picture until the desired portion is displayed.
- 4 Press **MENU/OK** to display a confirmation dialog.
- 5 Press **MENU/OK** again to save the cropped copy to a separate file.



- The higher the zoom ratio, the smaller the number of pixels in the cropped copy.
- If the size of the final copy will be **640**, **YES** will be displayed in yellow.
- All copies have an aspect ratio of 3:2.

RESIZE

Create a small copy of the current picture.

- 1 Display the desired picture.
- 2 Select **RESIZE** in the playback menu.
- 3 Highlight a size and press **MENU/OK** to display a confirmation dialog.
- 4 Press **MENU/OK** again to save the resized copy to a separate file.



The sizes available vary with the size of the original image.

PROTECT

Protect pictures from accidental deletion. Highlight one of the following options and press **MENU/OK**.

Option	Description
FRAME	Protect selected pictures. Press the focus stick (focus lever) left or right to view pictures and press MENU/OK to select or deselect. Press DISP/BACK when the operation is complete.
SET ALL	Protect all pictures.
RESET ALL	Remove protection from all pictures.

 Protected pictures will be deleted when the memory card is formatted.



 Protecting images currently selected for upload to paired smartphones or tablets removes upload marking.

IMAGE ROTATE

Rotate pictures.

- 1 Select **ON** for  **SCREEN SET-UP > AUTOROTATE PB.**
- 2 Display the desired picture.
- 3 Select **IMAGE ROTATE** in the playback menu.
- 4 Press the focus stick (focus lever) down to rotate the picture 90° clockwise, up to rotate it 90° counterclockwise.
- 5 Press **MENU/OK**. The picture will automatically be displayed in the selected orientation whenever it is played back on the camera.



- Protected pictures cannot be rotated. Remove protection before rotating pictures.
- The camera may not be able to rotate pictures created with other devices. Pictures rotated on the camera will not be rotated when viewed on a computer or on other cameras.
- Pictures taken with  **SCREEN SET-UP > AUTOROTATE PB** are automatically displayed in the correct orientation during playback.

RED EYE REMOVAL

Remove red-eye from portraits. The camera will analyze the image; if red-eye is detected, the image will be processed to create a copy with reduced red-eye.

- 1 Display the desired picture.
- 2 Select **RED EYE REMOVAL** in the playback menu.
- 3 Press **MENU/OK**.



- Results vary depending on the scene and the camera's success in detecting faces.
- The amount of time needed to process the image varies with the number of faces detected.
- Red eye cannot be removed from pictures that have already been processed using red-eye removal, which are indicated by a  icon during playback.
- Red eye removal cannot be performed on RAW images.

VOICE MEMO SETTING

Add a voice memo to the current photograph.

- 1 Select **ON** for **VOICE MEMO SETTING** in the playback menu.
- 2 Display a photo to which you wish to add a voice memo.
- 3 Press and hold the **AFON** button to record a voice memo. Recording ends after 30 s or when you release the button.



- The new memo will be recorded over any existing memos.
- Voice memos cannot be added to protected pictures.
- Deleting the picture also deletes the memo.

Playing Voice Memos

Pictures with voice memos are indicated by  icons during playback.

- To play the memo, press the **AFON** button.
- A progress bar will be displayed while the memo plays back.
- Volume can be adjusted by pressing **MENU/OK** to pause playback and then pressing the focus stick (focus lever) up or down to adjust the volume. Press **MENU/OK** again to resume playback. Volume can also be adjusted using  **SOUND SET-UP > PLAYBACK VOLUME**.

RATING

Rate pictures using stars.

- 1 Select **RATING** in the playback menu.
- 2 Rotate the front command dial to choose a picture and the rear command dial to choose a rating of from 0 to 5 stars ("★").



- The focus stick (focus lever) can be used in place of the front command dial to choose a picture.
- The rating dialog can also be displayed by pressing the **AEL** button in single-frame, nine-frame, or hundred-frame playback.
- Use touch controls to zoom in or out.

IMAGE TRANSFER ORDER

Select photos for upload to a paired smartphone or tablet.

- 1 Select **IMAGE TRANSFER ORDER > SELECT FRAMES** in the playback menu.
- 2 Highlight photos and press **MENU/OK** to select or deselect. Repeat until all the desired photos have been selected.
- 3 Press **DISP/BACK** to exit to playback.

 If **ON** is selected for both **CONNECTION SETTING > Bluetooth SETTINGS > Bluetooth ON/OFF** and **AUTO IMAGE TRANSFER**, upload will begin shortly after you exit to playback or turn the camera off.

-  • Image transfer orders can contain a maximum of 999 pictures.
- The following cannot be selected for upload:
 - Protected pictures
 - Movies
 - RAW images
 - "Gift" pictures (pictures taken with other cameras)
- If **PAIRING/TRANSFER ORDER** is selected for **CONNECTION SETTING > GENERAL SETTINGS > Wi-Fi BUTTON SETTING**, the **IMAGE TRANSFER ORDER** dialog can be displayed by pressing the **ISO** button.
- To remove upload marking from all pictures in the current order, select **IMAGE TRANSFER ORDER > RESET ORDER**.
- If **ON** is selected for **CONNECTION SETTING > Bluetooth SETTINGS > AUTO IMAGE TRANSFER**, photos will automatically be marked for upload as they are taken.

WIRELESS COMMUNICATION

Connect to smartphones running the latest version of the FUJIFILM Camera Remote app. The smartphone can then be used to:

- Control the camera and take pictures remotely
- Receive pictures uploaded from the camera
- Browse the pictures on the camera and download selected pictures
- Upload location data to the camera



For downloads and other information, visit:

http://app.fujifilm-dsc.com/en/camera_remote/

SLIDE SHOW

View pictures in an automated slide show. Press **MENU/OK** to start and press the focus stick (focus lever) right or left to skip ahead or back. Press **DISP/BACK** at any time during the show to view on-screen help. The show can be ended at any time by pressing **MENU/OK**.





The camera will not turn off automatically while a slide show is in progress.

PHOTOBOOK ASSIST

Create books from your favorite photos.

Creating a Photobook

- 1 Select **NEW BOOK** for  **PLAY BACK MENU > PHOTOBOOK ASSIST**.
- 2 Scroll through the images and press the focus stick (focus lever) up to select or deselect. Press **MENU/OK** to exit when the book is complete.
- 3 Highlight **COMPLETE PHOTOBOOK** and press **MENU/OK** (to select all photos for the book, choose **SELECT ALL**). The new book will be added to the list in the photobook assist menu.

-  • Neither photographs  or smaller nor movies can be selected for photobooks.
- The first picture selected becomes the cover image. A different picture can be selected at any time.

-  • Books can contain up to 300 pictures.
- Books that contain no photos are automatically deleted.

Viewing Photobooks

Highlight a book in the photobook assist menu and press **MENU/OK** to display the book, then press the focus stick (focus lever) left or right to scroll through the pictures.

Editing and Deleting Photobooks

Display the photobook and press **MENU/OK**. The following options will be displayed; select the desired option and follow the on-screen instructions.

- **EDIT:** Edit the book as described in “Creating a Photobook”.
- **ERASE:** Delete the book.

PC AUTO SAVE

Upload pictures from the camera to a computer running the latest version of FUJIFILM PC AutoSave (note that you must first install the software and configure the computer as a destination for images copied from the camera).



For downloads and other information, visit:

http://app.fujifilm-dsc.com/en/pc_autosave/

PRINT ORDER (DPOF)

Create a digital “print order” for DPOF-compatible printers.

- 1 Select **PLAY BACK MENU > PRINT ORDER (DPOF)**.
- 2 Select **WITH DATE** to print the date of recording on pictures, **WITHOUT DATE** to print pictures without dates, or **RESET ALL** to remove all pictures from the print order before proceeding.
- 3 Display a picture you wish to include in or remove from the print order.
- 4 Press the focus stick (focus lever) up or down to choose the number of copies (up to 99).

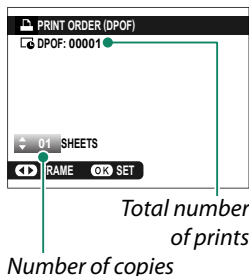

- To remove a picture from the order, press the focus stick down until the number of copies is 0.
- Repeat steps 3–4 to complete the print order.

- 5 The total number of prints is displayed in the monitor. Press **MENU/OK** to exit.

- The pictures in the current print order are indicated by a  icon during playback.
- Print orders can contain a maximum of 999 pictures from a single memory card.
- If a memory card is inserted containing a print order created by another camera, you will need to delete the order before creating as described above.

instax PRINTER PRINT

To print pictures to optional Fujifilm instax SHARE printers, first select **CONNECTION SETTING > instax PRINTER CONNECTION SETTING** and enter the instax SHARE printer name (SSID) and password, then follow the steps below.

- 1 Turn the printer on.
- 2 Select **PLAY BACK MENU > instax PRINTER PRINT**. The camera will connect to the printer.
- 3 Use the focus stick (focus lever) to display the picture you want to print, then press **MENU/OK**. The picture will be sent to the printer and printing will start.

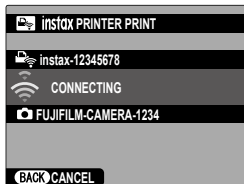

- Pictures taken with other cameras cannot be printed.
- The area printed is smaller than the area visible in the LCD monitor.
- The displays may vary depending on the printer connected.

DISP ASPECT

Choose the aspect ratio used for the display of still pictures on High Definition (HD) devices (this option is available only when an HDMI cable is connected).

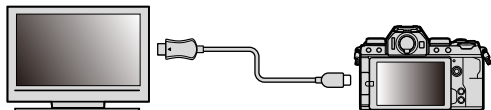

Options

16:9

3:2

-  Choose **16:9** to display photos with an aspect ratio of **16:9** full screen. The pictures will be displayed full screen with tops and bottoms cropped out.

The Setup Menus

8

USER SETTING

Adjust basic camera settings.

To access basic camera settings, press **MENU/OK**, select the **[SET UP]** tab, and choose **USER SETTING**.

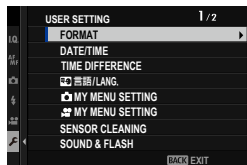



FORMAT

To format a memory card:

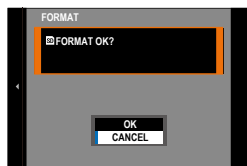
- 1 Select **[USER SETTING] > FORMAT** in the **[SET UP]** tab.
- 2 A confirmation dialog will be displayed. To format the memory card, highlight **OK** and press **MENU/OK**.





 To exit without formatting the memory card, select **CANCEL** or press **DISP/BACK**.

-  All data—including protected pictures—will be deleted from the memory card. Be sure important files have been copied to a computer or other storage device.
- Do not open the battery-chamber cover during formatting.

DATE/TIME



To set the camera clock:



- 1 Select  **USER SETTING** > **DATE/TIME** in the  (**SET UP**) tab.
- 2 Press the focus stick (focus lever) left or right to highlight the year, month, day, hour, or minute and press up or down to change. To change the order in which the year, month, and day are displayed, highlight the date format and press the focus stick up or down.
- 3 Press **MENU/OK** to set the clock.



TIME DIFFERENCE

Switch the camera clock instantly from your home time zone to the local time at your destination when traveling. To specify the difference between your local and home time zone:

- 1 Highlight  **LOCAL** and press **MENU/OK**.
- 2 Use the focus stick (focus lever) to choose the time difference between local time and your home time zone. Press **MENU/OK** when settings are complete.

To set the camera clock to local time, highlight  **LOCAL** and press **MENU/OK**. To set the clock to the time in your home time zone, select  **HOME**.



Options	
 LOCAL	 HOME

 If  **LOCAL** is selected,  will be displayed in yellow for about three seconds when the camera is turned on.



言語/LANG.

Choose a language.

MY MENU SETTING

Edit the items listed in the  (MY MENU) tab, a personalized custom menu of frequently-used photo menu options ( 243).

MY MENU SETTING

Edit the items listed in the  (MY MENU) tab, a personalized custom menu of frequently-used movie menu options ( 243).

SENSOR CLEANING

Remove dust from the camera image sensor.

Option	Description
OK	Clean the sensor immediately.
WHEN SWITCHED ON	Sensor cleaning will be performed when the camera is turned on.
WHEN SWITCHED OFF	Sensor cleaning will be performed when the camera turns off (sensor cleaning is not however performed if the camera turns off in playback mode).

 Dust that cannot be removed using sensor cleaning can be removed using a blower (📖 306).

SOUND & FLASH

Select **OFF** to disable the speaker, flash, illuminator, and self-timer lamp in situations in which camera sounds and lights may be unwelcome.

Options	
ON	OFF

RESET

Reset shooting or setup menu options to default values.

- 1 Highlight the desired option and press **MENU/OK**.

Option	Description
STILL MENU RESET	Reset all photo menu settings other than custom white balance and custom settings banks created using EDIT/SAVE CUSTOM SETTING to default values.
MOVIE MENU RESET	Reset all settings other than custom white balance options selected using  WHITE BALANCE .
SET-UP RESET	Reset all setup menu settings other than DATE/TIME , TIME DIFFERENCE , COPYRIGHT INFO , and connection-related CONNECTION SETTING options to default values.

- 2 A confirmation dialog will be displayed; highlight **OK** and press **MENU/OK**.

REGULATORY

To view electronic copies of the product model number, and other certificates, select  **USER SETTING > REGULATORY** in the setup menu.

SOUND SETTING

Make changes to camera sounds.

To access sound settings, press **MENU/OK**, select the **[SET UP]** tab, and choose **SOUND SET-UP**.

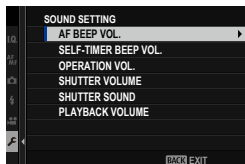

AF BEEP VOL.

Choose the volume of the beep that sounds when the camera focuses. The beep can be muted by selecting **OFF**.

Options

[Speaker icon] (high)

[Speaker icon] (medium)

[Speaker icon] (low)

OFF (mute)

SELF-TIMER BEEP VOL.

Choose the volume of the beep that sounds while the self-timer is active. The beep can be muted by selecting **OFF**.

Options

[Speaker icon] (high)

[Speaker icon] (medium)

[Speaker icon] (low)

OFF (mute)

OPERATION VOL.

Adjust the volume of the sounds produced when camera controls are operated. Choose OFF to disable control sounds.

Options (high) (medium) (low)OFF (mute)**SHUTTER VOLUME**

Adjust the volume of the sounds produced by the electronic shutter. Choose OFF to disable the shutter sound.

Options (high) (medium) (low)OFF (mute)**SHUTTER SOUND**

Choose the sound made by the electronic shutter.

Options 1 SOUND 1 2 SOUND 2 3 SOUND 3**PLAYBACK VOLUME**

Adjust the volume for movie playback.

Options

0

1

2

3

4

5

6

7

8

9

10

SCREEN SETTING

Make changes to display settings.

To access display settings, press **MENU/OK**, select the **SET UP** tab, and choose **SCREEN SET-UP**.

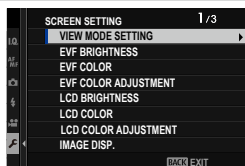

VIEW MODE SETTING

Adjust settings for eye sensor, EVF (electronic viewfinder), or LCD monitor view modes (📖 14).

EVF BRIGHTNESS

Adjust the brightness of the display in the electronic viewfinder.

Option	Description
AUTO	Automatic brightness adjustment.
MANUAL	Adjust brightness manually; choose from options between -7 and +5.

EVF COLOR

Adjust the hue of the display in the electronic viewfinder.

Options										
-5	-4	-3	-2	-1	0	+1	+2	+3	+4	+5

EVF COLOR ADJUSTMENT

Adjust the color of the display in the electronic viewfinder.

- 1 Adjust colors using the focus stick (focus lever).

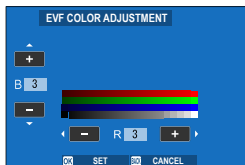

- 2 Press **MENU/OK**.

LCD BRIGHTNESS

Adjust monitor brightness.

Options										
-5	-4	-3	-2	-1	0	+1	+2	+3	+4	+5

LCD COLOR

Adjust monitor hue.

Options										
-5	-4	-3	-2	-1	0	+1	+2	+3	+4	+5

LCD COLOR ADJUSTMENT

Adjust the color of the display in the LCD monitor.

- 1 Adjust colors using the focus stick (focus lever).
- 2 Press **MENU/OK**.

IMAGE DISP.

Choose how long images are displayed after shooting.

Option	Description
CONTINUOUS	Pictures are displayed until the MENU/OK button is pressed or the shutter button is pressed halfway. To zoom in on the active focus point, press the center of the focus stick (focus lever); press again to cancel zoom.
1.5 SEC	Pictures are displayed for the selected time or until the shutter button is pressed halfway.
0.5 SEC	
OFF	Pictures are not displayed after shooting.



- Colors may differ slightly from those in the final image.
- “Noise” mottling may be visible at high sensitivities.

AUTOROTATE DISPLAYS

Choose whether the indicators in the viewfinder and LCD monitor rotate to match camera orientation.

Options	
ON	OFF

PREVIEW EXP./WB IN MANUAL MODE

Choose whether to enable exposure and/or white balance preview in manual exposure mode.

Option	Description
PREVIEW EXP./WB	Enable exposure and white balance preview.
PREVIEW WB	Preview white balance only. Choose this option in situations in which exposure and white balance are likely to change during shooting, as may be the case when you use a flash with an incandescent monitoring lamp.
OFF	Disable exposure and white balance preview. Choose this option when using a flash or on other occasions on which exposure may change when the picture is taken.

NATURAL LIVE VIEW

Choose whether the effects of film simulation, white balance, and other settings are visible in the monitor.

Option	Description
ON	The effects of camera settings are not visible in the monitor, but shadows in low-contrast, back-lit scenes and other hard-to-see subjects more visible. Colors and tone will differ from those in the final picture. The display will however be adjusted to show the effects of monochrome and sepia settings.
OFF	The effects of film simulation, white balance, and other settings can be previewed in the monitor.



F-Log VIEW ASSIST

Select **ON** to display a tone-corrected preview (equivalent to BT.709) when recording or viewing F-log movies.

Options	
ON	OFF

FRAMING GUIDELINE

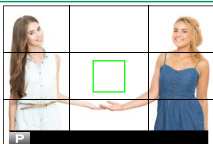
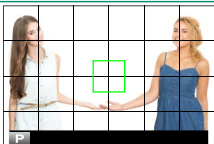
Choose a framing grid for shooting mode.

			Option		
			GRID 9	GRID 24	HD FRAMING
Display					
	For "rule of thirds" composition.	A six-by-four grid.	Frame HD pictures in the crop shown by the lines at the top and bottom of the display.		

 Framing guides are not shown at default settings but can be displayed using **SCREEN SET-UP > DISP. CUSTOM SETTING** (📖 218).

AUTOROTATE PB

Choose **ON** to automatically rotate “tall” (portrait-orientation) pictures during playback.

Options	
ON	OFF

FOCUS SCALE UNITS

Choose the units used for the focus distance indicator.

Options	
METERS	FEET

APERTURE UNIT FOR CINEMA LENS

Choose whether the camera displays aperture as a T-number (used for movie camera lenses) or an f/-number (used for still camera lenses) when an optional FUJINON MKX-series lens is attached. For information on using cinema lenses, see the documentation provided with the lens.

Option	Description
T NUMBER	A measure of lens aperture commonly used by cinematographers. Lens transmittance is taken into account to better calculate exposure.
F NUMBER	A measure of lens aperture commonly used by photographers. Lens transmittance is assumed to be 100%, meaning that the same aperture may produce different exposures depending on the lens.

DISP. CUSTOM SETTING

Choose the items shown in the standard indicator display (📖 17).

LARGE INDICATORS MODE(EVF)

Select **ON** to display large indicators in the electronic viewfinder. The indicators displayed can be selected using **SCREEN SET-UP > LARGE INDICATORS DISP. SETTING**.



OFF



ON

Some icons are not displayed when **ON** is selected for **LARGE INDICATORS MODE(EVF)** (11).

If **LARGE INDICATORS MODE** is assigned to a function button, the button can be used to toggle **LARGE INDICATORS MODE** on (**ON**) and off (**OFF**) (251).

LARGE INDICATORS MODE(LCD)

Select **ON** to display large indicators in the LCD monitor. The indicators displayed can be selected using **SCREEN SET-UP > LARGE INDICATORS DISP. SETTING**.

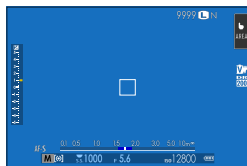

OFF

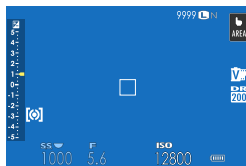

ON

Some icons are not displayed when **ON** is selected for **LARGE INDICATORS MODE(LCD)** (13).

If **LARGE INDICATORS MODE** is assigned to a function button, the button can be used to toggle **LARGE INDICATORS MODE** on (**ON**) and off (**OFF**) (251).

LARGE INDICATORS DISP. SETTING

Choose the indicators displayed when **ON** is selected for **SCREEN SET-UP > LARGE INDICATORS MODE(EVF)** or **LARGE INDICATORS MODE(LCD)**.

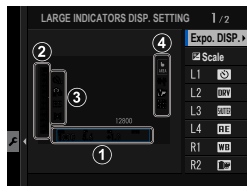

Option	Description
① Expo. DISP.	Choose the items listed at the bottom of the display. Selected items are indicated by check marks (☑); to deselect, highlight the check marks and press MENU/OK .
② Scale	Select ON to display the exposure indicator.
③ L1, L2, L3, L4	Choose up to four large icons for display on the left side of the screen.
④ R1, R2, R3, R4	Choose up to four large icons for display on the right side of the screen.

INFORMATION CONTRAST ADJ.

Adjust display contrast.

Option	Description
HIGH CONTRAST	High contrast.
STANDARD	Normal contrast.
LOW CONTRAST	Low contrast.
DARK AMBIENT LIGHTING	Contrast adjusted for dim ambient lighting.

Q MENU BACKGROUND

Choose the background color used for the quick menu when it is displayed during still photography.

Options	
TRANSPARENT	BLACK

Q MENU BACKGROUND

Choose the background color used for the quick menu when it is displayed during movie recording.

Options	
TRANSPARENT	BLACK

BUTTON/DIAL SETTING

Access options for camera controls.

To access control options, press **MENU/OK**, select the **SET UP** tab, and choose **BUTTON/DIAL SETTING**.

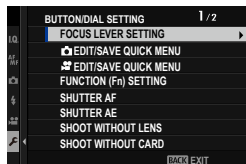

FOCUS LEVER SETTING

Choose the functions performed by pressing the center of the focus stick (focus lever) or by pressing the stick up, down, left, or right.

PUSH

Option	Description
OFF	Pressing the center of the stick has no effect.
EDIT FOCUS AREA	Press the center of the stick to view a focus-area display where you can choose the focus area. If FACE DETECTION ON is selected for FACE/EYE DETECTION SETTING , Intelligent Face Detection will be temporarily disabled.
ZOOM	Press the center of the stick to zoom in on the active focus area (78). If FACE DETECTION ON is selected for FACE/EYE DETECTION SETTING , Intelligent Face Detection will be temporarily disabled.

TILT 

Option	Description
OFF	Pressing the stick up, down, left, or right has no effect.
DIRECT AF POINT SELECTION	Choose the focus area without leaving the shooting display.
EDIT FOCUS AREA	Press the stick up, down, left, or right to view a focus-area display and choose the focus area.
DIRECT AF POINT SELECTION/FACE SELECT	Choose the focus area without leaving the shooting display. If FACE DETECTION ON is selected for FACE/EYE DETECTION SETTING , you can also choose the face used for focus.

 **EDIT/SAVE QUICK MENU**

Choose the items displayed in the quick menu during still photography ( 248).

 **EDIT/SAVE QUICK MENU**

Choose the items displayed in the quick menu when filming movies ( 248).

FUNCTION (Fn) SETTING

Choose the roles played by the function buttons ( 251).

SHUTTER AF

Choose whether the camera focuses when the shutter button is pressed halfway.

Option	Description
AF-S	<ul style="list-style-type: none">• ON: Focus locks when the shutter button is pressed halfway.• OFF: No focus operation is performed when the shutter button is pressed halfway.
AF-C	<ul style="list-style-type: none">• ON: The camera focuses while the shutter button is pressed halfway.• OFF: No focus operation is performed when the shutter button is pressed halfway.

SHUTTER AE

If **ON** is selected, exposure will lock while the shutter button is pressed halfway.

-  Select **OFF** to allow the camera to adjust exposure before each shot taken in burst mode.

SHOOT WITHOUT LENS

Choose **ON** to enable the shutter release when no lens is attached.

Options	
ON	OFF

SHOOT WITHOUT CARD

Choose whether the shutter can be released without a memory card inserted in the camera.

Option	Description
ON	When no memory card is inserted, the shutter can be released to test camera function and the shooting and setup menus can be displayed.
OFF	The shutter is disabled if no memory card is inserted, preventing accidental loss of pictures taken without a memory card.

FOCUS RING

Choose the direction in which the focus ring is rotated to increase the focus distance.

Options	
 CW (clockwise)	 CCW (counterclockwise)

FOCUS RING OPERATION

Choose how the camera adjusts focus in response to the movement of the focus ring.

Option	Description
NONLINEAR	Focus is adjusted at the same rate as the ring is rotated.
LINEAR	Focus is adjusted linearly according to the amount the ring is rotated, but the focusing speed is unaffected by the speed the ring is rotated.

AE/AF-LOCK MODE

This option determines the behavior of the button to which exposure and/or focus lock is assigned.

Option	Description
AE&AF ON WHEN PRESSING	Exposure and/or focus will lock while the button is pressed.
AE&AF ON/OFF SWITCH	Exposure and/or focus will lock when the button is pressed and remain locked until it is pressed again.

AWB-LOCK MODE

Choose the behavior of function buttons assigned auto white balance (AWB) lock. Auto white balance lock is used to lock white balance at the value metered by the camera when **AUTO** is selected for white balance.

Option	Description
AWB ON WHEN PRESSING	Auto white balance locks while the button is pressed.
AWB ON/OFF SWITCH	Press the button once to lock auto white balance and again to end the lock.

TOUCH SCREEN SETTING

Enable or disable touch-screen controls.

TOUCH SCREEN SETTING

Option	Description
ON	The LCD monitor functions as a touch screen during shooting.
OFF	Touch controls disabled.

DOUBLE TAP SETTING

Option	Description
ON	Tap the LCD monitor twice to zoom in on your subject during shooting.
OFF	Touch zoom disabled.

TOUCH FUNCTION

Option	Description
ON	Enable touch-function gestures.
OFF	Disable touch-function gestures.

TOUCH SCREEN SETTING

Option	Description
ON	The LCD monitor functions as a touch screen during playback.
OFF	Touch controls disabled.

EVF TOUCH SCREEN AREA SETTINGS

Select the area of the LCD monitor used for touch controls while the viewfinder is active. The area used for touch controls can be selected from:

Option	Description
<input type="checkbox"/>	All.
<input checked="" type="checkbox"/>	Right half.
<input checked="" type="checkbox"/>	Top right quarter.
<input checked="" type="checkbox"/>	Bottom right quarter.
<input checked="" type="checkbox"/>	Left half.
<input checked="" type="checkbox"/>	Top left quarter.
<input checked="" type="checkbox"/>	Bottom left quarter.
OFF	Touch controls disabled.

POWER MANAGEMENT

Adjust power management settings.

To access power management settings, press **MENU/OK**, select the **SET UP** tab, and choose **POWER MANAGEMENT**.

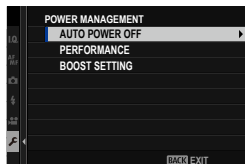

AUTO POWER OFF

Choose the length of time before the camera turns off automatically when no operations are performed. Shorter times increase battery life; if **OFF** is selected, the camera must be turned off manually.

Options					
5 MIN	2 MIN	1 MIN	30 SEC	15 SEC	OFF

PERFORMANCE

Select **BOOST** to improve focus and EVF display performance.

Option	Description
BOOST	Boost camera focus and EVF display performance. The battery drains faster than when is NORMAL selected.
NORMAL	Choose for standard focus and EVF display performance and battery endurance.

BOOST SETTING

Adjust the behavior of the EVF and LCD monitor when **BOOST** is selected for **PERFORMANCE**.

Option	Description
LOW LIGHT PRIORITY	Display brightness is adjusted to make subjects in shadows easier to see. Motion blur may cause ghosting.
RESOLUTION PRIORITY	Display resolution is increased to make details easier to see.
FRAME RATE PRIORITY	The refresh rate for the EVF is increased, smoothing motion.

SAVE DATA SETTING

Make changes to file management settings.

To access file management settings, press **MENU/OK**, select the **SET UP** tab, and choose **SAVE DATA SET-UP**.

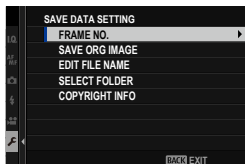

FRAME NO.

New pictures are stored in image files named using a four-digit file number assigned by adding one to the last file number used. The file number is displayed during playback as shown. **FRAME NO.** controls whether file numbering is reset to 0001 when a new memory card is inserted or the current memory card is formatted.

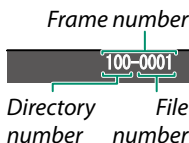

Option	Description
CONTINUOUS	Numbering continues from the last file number used or the first available file number, whichever is higher. Choose this option to reduce the number of pictures with duplicate file names.
RENEW	Numbering is reset to 0001 after formatting or when a new memory card is inserted.

- If the frame number reaches 999-9999, the shutter release will be disabled. Format the memory card after transferring to a computer any pictures you wish to keep. Next, reset frame numbering to 100-0001 by inserting a formatted memory card, selecting **RENEW** for **FRAME NO.**, and taking a picture. You can then set **FRAME NO.** to **CONTINUOUS** once more and continue shooting.
- Selecting **USER SETTING > RESET** does not reset the file number.
- Frame numbers for pictures taken with other cameras may differ.

SAVE ORG IMAGE

Choose **ON** to save unprocessed copies of pictures taken using **RED EYE REMOVAL**.

Options	
ON	OFF

EDIT FILE NAME

Change the file name prefix. sRGB images use a four-letter prefix (default "DSCF"), Adobe RGB images a three-letter prefix ("DSF") preceded by an underscore.

Option	Default prefix	Sample file name
sRGB	DSCF	ABCD0001
AdobeRGB	_DSF	_ABC0001

SELECT FOLDER

Create folders and choose the folder used to store subsequent pictures.

Option	Description
SELECT FOLDER	To choose the folder in which subsequent pictures will be stored, press the focus stick (focus lever) up or down to highlight an existing folder and press MENU/OK .
CREATE FOLDER	Enter a five-character folder name to create a new folder in which to store subsequent pictures. The new folder will be created with the next picture you take and subsequent pictures will be stored in that folder.

COPYRIGHT INFO

Copyright information, in the form of Exif tags, can be added to new images as they are taken. Changes to copyright information are reflected only in images taken after the changes are made.

Option	Description
DISP COPYRIGHT INFO	View the current copyright information.
ENTER AUTHOR'S INFO	Enter the creator's name.
ENTER COPYRIGHT INFO	Enter the name of the copyright holder.
DELETE COPYRIGHT INFO	Delete the current copyright information. This change applies only to images taken after this option is selected; copyright information recorded with existing images is not affected.

CONNECTION SETTING

Adjust settings for connection to other devices.

To access connection settings, press **MENU/OK**, select the **[SET UP]** tab, and choose **CONNECTION SETTING**.

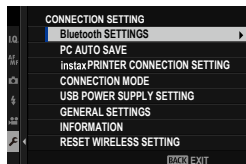

For more information on wireless connections, visit:
<http://fujifilm-dsc.com/wifi/>

Bluetooth SETTINGS

Adjust Bluetooth settings.

Option	Description
PAIRING REGISTRATION	Pair the camera with a smartphone running the FUJIFILM Camera Remote app.
SELECT PAIRING DESTINATION	Choose a connection from a list of devices with which the camera has been paired using PAIRING REGISTRATION . Select NO CONNECTION to exit without connecting.
DELETE PAIRING REG.	Delete pairing information for selected devices. Choose the device in the device list. The selected device will also be removed from the devices listed in SELECT PAIRING DESTINATION .
Bluetooth ON/OFF	<ul style="list-style-type: none">• ON: The camera automatically establishes a Bluetooth connection with paired devices when turned on.• OFF: The camera does not connect via Bluetooth.
AUTO IMAGE TRANSFER	<ul style="list-style-type: none">• ON: Mark photos for upload as they are taken. Mark JPEG photos for upload as they are taken.• OFF: Photos are not marked for upload as they are taken.
SMARTPHONE SYNC. SETTING	Choose whether to synchronize the camera to the time and/or location provided by a paired smartphone. <ul style="list-style-type: none">• LOCATION&TIME: Synchronize the time and location.• LOCATION: Synchronize the location.• TIME: Synchronize the time.• OFF: Synchronization off.

- Install the latest version of the FUJIFILM Camera Remote app on your smartphone or tablet before pairing the device with your camera or uploading images.
- When **ON** is selected for both **Bluetooth ON/OFF** and **AUTO IMAGE TRANSFER** or images are currently selected for upload using the **IMAGE TRANSFER ORDER** option in the  (playback) menu, upload to paired devices will begin shortly after you exit to playback or turn the camera off. **IMAGE TRANSFER ORDER** can also be used to select pictures for upload when **AUTO IMAGE TRANSFER** is off.

PC AUTO SAVE

Adjust settings for connection to computers via wireless LAN.

Option	Description
PC AUTO SAVE SETTING	Choose the method used for connection to computers via a wireless LAN. <ul style="list-style-type: none"> • SIMPLE SETUP: Connect using WPS. • MANUAL SETUP: Choose the network from a list (SELECT FROM NETWORK LIST) or enter the name manually (ENTER SSID).
DELETE REGISTERED DESTINATION PC	Remove selected destinations.
DETAILS OF PREVIOUS CONNECTION	View computers to which the camera has recently connected.

- These settings also apply when pictures are downloaded to a computer using “FUJIFILM PC AutoSave” software.

instax PRINTER CONNECTION SETTING

Adjust settings for connection to optional Fujifilm instax SHARE printers.

The Printer Name (SSID) and Password

The printer name (SSID) can be found on the bottom of the printer; the default password is "1111". If you have already chosen a different password to print from a smartphone, enter that password instead.

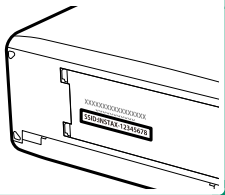

CONNECTION MODE

Adjust settings for connection to external devices.

Option	Description
USB CARD READER	Connecting the camera to a computer via USB automatically enables data transfer mode, allowing data to be copied to the computer. The camera functions normally when not connected.
X WEBCAM	The camera can be used as a webcam when connected to a computer running FUJIFILM X Webcam.
USB RAW CONV./ BACKUP RESTORE	<p>Connecting the camera to a computer via USB automatically enables USB RAW conversion/backup restore mode. The camera functions normally when not connected.</p> <ul style="list-style-type: none"> • USB RAW CONV. (requires FUJIFILM X RAW STUDIO): Use the camera's image processing engine to rapidly convert RAW files to high-quality JPEG images. • BACKUP RESTORE (requires FUJIFILM X Acquire): Save and load camera settings. Reconfigure the camera in an instant or share settings with other cameras of the same type.

 For information on compatible computer software, see “Software for Use with Your Camera” (📖 294).

USB POWER SUPPLY SETTING

Choose whether power is supplied to the camera when it is connected to a computer or other device via a USB cable.





Option	Description
ON	The camera draws power from the connected device, reducing the drain on the camera battery.
OFF	The camera does not draw power from the connected device.

 The camera cannot draw power from Lightning connections or from devices that do not supply power. Select **OFF** before connecting the camera to such devices. The connection may not be available for data transfer or the like when **ON** is selected.

 Regardless of the option selected, the battery will charge while the camera is off.

GENERAL SETTINGS

Adjust settings for connection to wireless networks.

Option	Description
NAME	Choose a name (NAME) to identify the camera on the wireless network (the camera is assigned a unique name by default).
RESIZE IMAGE FOR SMARTPHONE 	Choose whether to resize images for upload to smartphones. Resizing applies only to the copy uploaded to the smartphone; the original is not affected. <ul style="list-style-type: none"> • ON: Larger images are resized to  for upload. • OFF: Images are uploaded at their original size.
GEOTAGGING	Choose whether location data downloaded from a smartphone are embedded in pictures as they are taken.
LOCATION INFO	Display the location data last downloaded from a smartphone.
 BUTTON SETTING	Choose the role played by the ISO button during playback. <ul style="list-style-type: none"> •  PAIRING/TRANSFER ORDER: The ISO button can be used for pairing and selecting images for transfer during playback. •  WIRELESS COMMUNICATION: The ISO button can be used during playback to establish wireless connections.

INFORMATION

View the camera's MAC and Bluetooth address.

RESET WIRELESS SETTING

Restore wireless settings to their default values.



Shortcuts

9

Shortcut Options

Customize camera controls to suit your style or situation.

Frequently-used options can be added to “my menu” or the **Q** menu or assigned to the function buttons, the function dial, or touch function button flick gestures for direct access:

Shortcut Option	Description	
“My menu”	Add frequently-used options to this custom menu, which can be viewed by pressing MENU/OK and selecting the MY (“MY MENU”) tab.	243
The Quick Menu	The Q menu is displayed by pressing the Q button. Use the Q menu to view or change the options selected for frequently-used menu items.	245
The function button	Use the function (Fn ,  , ISO , Q , AEL , and AFON) button for direct access to selected features.	251
The function dial	Rotate the Fn (function) dial for direct access to selected features.	254
Touch-function gestures	Use touch function button flick gestures (T-Fn1 , T-Fn2 , T-Fn3 , and T-Fn4) for direct access to selected features.	255

MY MENU

Access a personalized menu of frequently-used options.

To display “my menu”, press **MENU/OK** in the shooting display and select the **MY** (MY MENU) tab.

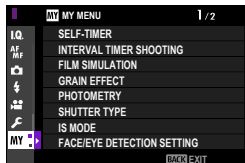

 The **MY** tab is only available if options have been assigned to **MY MY MENU**.

MY MENU SETTING

To choose the items listed in the **MY** (MY MENU) tab:

- 1 In the setup menu, select **USER SETTING > MY MENU SETTING** or **MY MENU SETTING**.

 To reorder items, select **RANK ITEMS**.
To delete items, select **REMOVE ITEMS**.

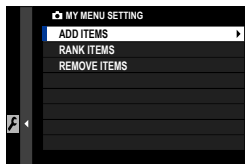

- 2 Press the focus stick (focus lever) up or down to highlight **ADD ITEMS** and press **MENU/OK**. Options that can be added to “my menu” are highlighted in blue.

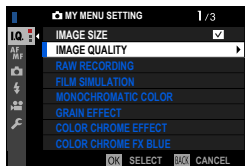

 Items currently in “my menu” are indicated by check marks.

- 3 Choose a position for the item and press **MENU/OK**. The item will be added to “my menu”.

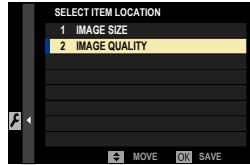

- 4 Press **MENU/OK** to return to the edit display.
- 5 Repeat Steps 3 and 4 until all the desired items have been added.

 “My menu” can contain up to 16 items.

The Quick Menu

Use the quick menu for quick access to selected options. To view the quick menu, press the **Q** button.

The Quick Menu Display

The quick menu offers different options in photo and movie modes. At default settings, it contains the following items:

Still photography

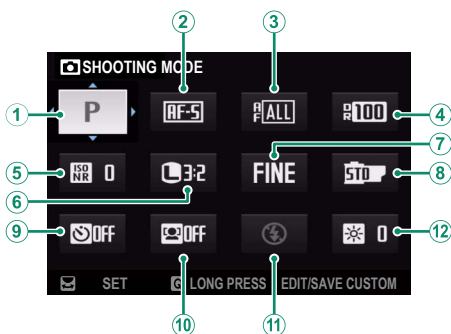

Default

① SHOOTING MODE	⑦ IMAGE QUALITY
② FOCUS MODE	⑧ FILM SIMULATION
③ AF MODE	⑨ SELF-TIMER
④ DYNAMIC RANGE	⑩ FACE/EYE DETECTION SETTING
⑤ HIGH ISO NR	⑪ FLASH FUNCTION SETTING
⑥ IMAGE SIZE	⑫ EVF/LCD BRIGHTNESS

The quick menu shows the options currently selected for items ②–⑫, which can be changed.

Movie recording

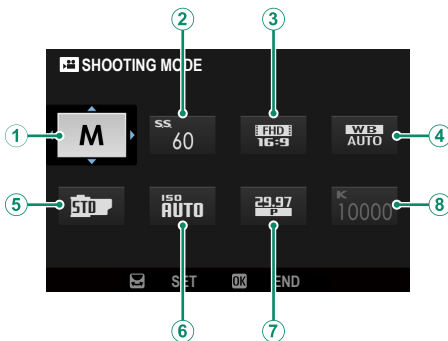

Default

① SHOOTING MODE	⑤ 🎞️ FILM SIMULATION
② SHUTTER SPEED	⑥ 🧑‍🚒 ISO
③ MOVIE MODE RESOLUTION/ ASPECT RATIO	⑦ MOVIE MODE FRAME RATE
④ 🧑‍🚒 WHITE BALANCE	⑧ WHITE BALANCE COLOR TEMP. (WHEN K SELECTED)

The quick menu shows the options currently selected for items ②–⑧, which can be changed.

Viewing and Changing Settings

- 1 Press **Q** to display the quick menu during shooting.

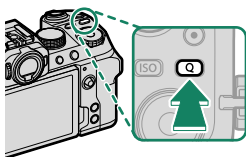

- 2 Use the focus stick (focus lever) to highlight items and rotate the rear command dial to change.

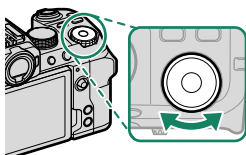
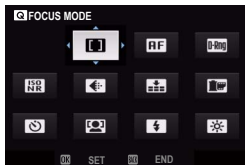

 When **DISABLE** is selected for **IMAGE QUALITY SETTING > EDIT/SAVE CUSTOM SETTING > AUTO UPDATE SETTING** in modes **C1** through **C4**, settings altered from saved values are indicated by red icons.

- 3 Press **Q** to exit when settings are complete.

-  The quick menu can also be edited using touch controls.
- Using **FUNCTION/DIAL SETTING > FUNCTION (Fn) SETTING**, you can assign the **Q** button roles normally reserved for the function buttons or assign the **Q** button's default role to a function button (251).
- To disable the **Q** (quick menu) button, select **NONE** for **FUNCTION/DIAL SETTING > FUNCTION (Fn) SETTING > Q BUTTON SETTING**.

Editing the Quick Menu



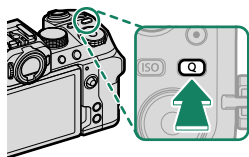

To choose the items displayed in the quick menu:

- 1 Press and hold the **Q** button during shooting.





 Whether the camera displays the photo or movie quick menu depends on the position of the mode dial.

- 2 The current quick menu will be displayed; use the focus stick (focus lever) to highlight the item you wish to change and press **MENU/OK**.
- 3 Highlight the item you wish to change and press **MENU/OK**. The following can be assigned to the quick menu.

 The quick menus can also be edited using  **BUTTON/DIAL SETTING >**  **EDIT/SAVE QUICK MENU** or  **EDIT/SAVE QUICK MENU**.







Available Items (Still Photography)

Choose from:

- IMAGE SIZE
- IMAGE QUALITY
- FILM SIMULATION
- GRAIN EFFECT
- COLOR CHROME EFFECT
- COLOR CHROME FX BLUE
- DYNAMIC RANGE
- D RANGE PRIORITY
- WHITE BALANCE
- WHITE BALANCE COLOR TEMP. (WHEN  SELECTED)
- HIGHLIGHT TONE
- SHADOW TONE
- COLOR
- SHARPNESS
- CLARITY
- HIGH ISO NR
- FOCUS MODE
- AF MODE
- AF-C CUSTOM SETTINGS
- FACE/EYE DETECTION SETTING
- MF ASSIST
- TOUCH SCREEN MODE
- SELF-TIMER
- PHOTOMETRY
- SHUTTER TYPE
- FLICKER REDUCTION
- ISO
- FLASH FUNCTION SETTING
- FLASH COMPENSATION
- MOVIE MODE RESOLUTION/ASPECT RATIO
- MOVIE MODE FRAME RATE
- MOVIE MODE BIT RATE
- FULL HD HIGH SPEED REC
-  IS MODE
-  IS MODE BOOST
- INTERNAL/EXTERNAL MIC LEVEL ADJUSTMENT
- SOUND & FLASH
- EVF/LCD BRIGHTNESS
- EVF/LCD COLOR
- NONE

 To disable the function button, choose **NONE**.

Available Items (Movies)

- FILM SIMULATION
- DYNAMIC RANGE
- WHITE BALANCE
- WHITE BALANCE COLOR TEMP.
(WHEN  SELECTED)
- HIGHLIGHT TONE
- SHADOW TONE
- COLOR
- SHARPNESS
- HIGH ISO NR
- FACE/EYE DETECTION SETTING
- MF ASSIST
- TOUCH SCREEN MODE
- PHOTOMETRY
- ISO
- MOVIE MODE RESOLUTION/
ASPECT RATIO
- MOVIE MODE FRAME RATE
- MOVIE MODE BIT RATE
- FULL HD HIGH SPEED REC
- FOCUS MODE
- MOVIE AF MODE
- FIX MOVIE CROP MAGNIFICATION 
-  IS MODE
-  IS MODE BOOST
- SHUTTER SPEED
- APERTURE (MOVIE OPTIMIZED
CONTROL  )
- INTERNAL/EXTERNAL MIC LEVEL
ADJUSTMENT
- SOUND & FLASH
- EVF/LCD BRIGHTNESS
- EVF/LCD COLOR
- NONE

 To disable the function button, choose **NONE**.

Function Controls

Each of the function (**Fn**, **⊙**, **ISO**, **Q**, **AEL**, and **AFON**) buttons, the **Fn** (function) dial, and touch-function (**T-Fn1**, **T-Fn2**, **T-Fn3**, and **T-Fn4**) buttons flick gestures can be assigned its own role.

The Function Buttons

Assign roles to the function (**Fn**, **⊙**, **ISO**, **Q**, **AEL**, and **AFON**) buttons for quick access.

Function Button Defaults



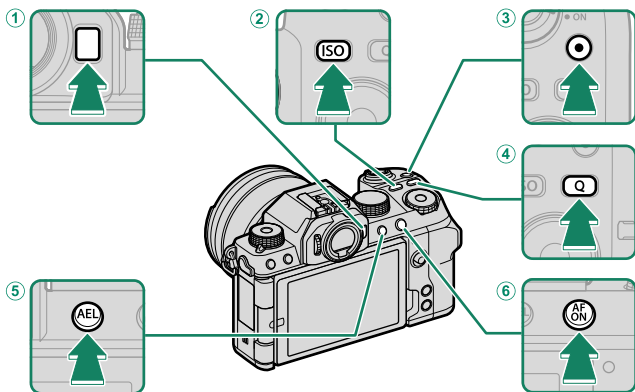

The default assignments are:



	Function buttons	Default
①	Fn button	WHITE BALANCE
②	ISO button	ISO
③	⊙ (movie recording) button	MOVIE RECORDING RELEASE
④	Q (quick menu) button	QUICK MENU
⑤	AEL (exposure lock) button	AE LOCK ONLY
⑥	AFON button	AF-ON

Assigning Roles to the Function Buttons

The roles played by the function buttons can be selected using the  **FUNCTION/DIAL SETTING > FUNCTION (Fn) SETTING** option in the setup menu.

- IMAGE SIZE
- IMAGE QUALITY
- RAW
- FILM SIMULATION
- GRAIN EFFECT
- COLOR CHROME EFFECT
- COLOR CHROME FX BLUE
- DYNAMIC RANGE
- D RANGE PRIORITY
- WHITE BALANCE
- CLARITY
- FOCUS AREA
- FOCUS CHECK
- FOCUS MODE
- AF MODE
- AF-C CUSTOM SETTINGS
- FACE DETECTION ON/OFF
- AF RANGE LIMITER
- FOCUS CHECK LOCK
- SPORTS FINDER MODE
- PRE-SHOT 
- SELF-TIMER
- AE BKT SETTING
- FOCUS BKT SETTING
- PHOTOMETRY
- SHUTTER TYPE
- FLICKER REDUCTION
- ISO
- IS MODE
- WIRELESS COMMUNICATION
- FLASH COMPENSATION
- FLASH FUNCTION SETTING
- TTL-LOCK
- MODELING FLASH
- MOVIE RECORDING RELEASE
- FULL HD HIGH SPEED REC
- FIX MOVIE CROP MAGNIFICATION  **1.29x**
-  IS MODE BOOST
- ZEBRA SETTING
- INTERNAL/EXTERNAL MIC LEVEL ADJUSTMENT
- MOVIE OPTIMIZED CONTROL 
- VIEW MODE SETTING
- PREVIEW DEPTH OF FIELD
- PREVIEW EXP./WB IN MANUAL MODE
- NATURAL LIVE VIEW
- HISTOGRAM
- ELECTRONIC LEVEL
- LARGE INDICATORS MODE
- F-Log VIEW ASSIST
- AE LOCK ONLY
- AF LOCK ONLY
- AE/AF LOCK
- AF-ON
- AWB LOCK ONLY
- PERFORMANCE
- AUTO IMAGE TRANSFER
- SELECT PAIRING DESTINATION
- Bluetooth ON/OFF
- QUICK MENU
- PLAYBACK
- NONE

 To disable the function button, choose **NONE**.

AF-ON

Controls to which **AF-ON** is assigned can be used for autofocus.

MODELING FLASH

If **MODELING FLASH** is selected when a compatible shoe-mounted flash unit is attached, you can press the control to test-fire the flash and check for shadows and the like (modeling flash).

TTL-LOCK

If **TTL-LOCK** is selected, you can press the control to lock flash output according to the option selected for **FLASH SETTING > TTL-LOCK MODE** (📖 149).

The Function Dial

Rotate the **Fn** (function) dial for direct access to selected features.

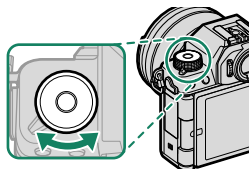

The role played by the function dial can be selected using **▶ BUTTON/DIAL SETTING > FUNCTION (Fn) SETTING**.

- EXPO. COMP.
- IMAGE SIZE
- IMAGE QUALITY
- FILM SIMULATION
- GRAIN EFFECT
- COLOR CHROME EFFECT
- COLOR CHROME FX BLUE
- DYNAMIC RANGE
- D RANGE PRIORITY
- WHITE BALANCE
- CLARITY
- FOCUS MODE
- AF MODE
- AF-C CUSTOM SETTINGS
- FACE DETECTION ON/OFF
- AF RANGE LIMITER
- SPORTS FINDER MODE
- PRE-SHOT **ES**
- SELF-TIMER
- PHOTOMETRY
- SHUTTER TYPE
- FLICKER REDUCTION
- ISO
- IS MODE
- FLASH COMPENSATION
- FLASH FUNCTION SETTING
- FULL HD HIGH SPEED REC
- FIX MOVIE CROP MAGNIFICATION **CROP 1.29x**
- IS MODE BOOST
- ZEBRA SETTING
- INTERNAL/EXTERNAL MIC LEVEL ADJUSTMENT
- MOVIE OPTIMIZED CONTROL
- DEFAULT
- DEFAULT (WHEN SET TO **M**)
- NONE

- To disable the function dial, select **NONE**.
- If **DEFAULT** is selected, the role played by the function dial will be tailored to the mode currently chosen with the mode dial (📖 7).
- If **DEFAULT (WHEN SET TO **M**)** is selected, the control will be assigned **EXPO. COMP.** instead of **FILM SIMULATION** in mode **M** (manual).

Touch-Function Gestures

Assign roles to touch-function gestures (**T-Fn1**, **T-Fn2**, **T-Fn3**, or **T-Fn4**) for quick access to selected features.

 Touch-function gestures are disabled by default. To enable touch-function gestures, select **ON** for  **BUTTON/DIAL SETTING > TOUCH SCREEN SETTING >  TOUCH FUNCTION**.

Touch-Function Gesture Defaults



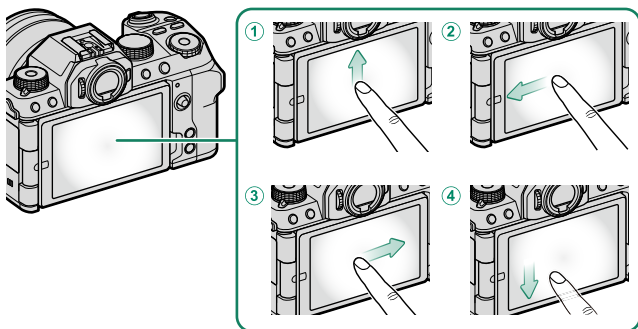

The default assignments for the different gestures are:



Touch-Function Gestures	Default
① T-Fn1 (flick up)	HISTOGRAM
② T-Fn2 (flick left)	SPORTS FINDER MODE
③ T-Fn3 (flick right)	LARGE INDICATORS MODE
④ T-Fn4 (flick down)	ELECTRONIC LEVEL

Assigning Roles to Touch-Function Gestures

The roles played by touch-function gestures can be selected using the  **BUTTON/DIAL SETTING > FUNCTION (Fn) SETTING** option in the setup menu.

- IMAGE SIZE
- IMAGE QUALITY
- RAW
- FILM SIMULATION
- GRAIN EFFECT
- COLOR CHROME EFFECT
- COLOR CHROME FX BLUE
- DYNAMIC RANGE
- D RANGE PRIORITY
- WHITE BALANCE
- CLARITY
- FOCUS AREA
- FOCUS CHECK
- FOCUS MODE
- AF MODE
- AF-C CUSTOM SETTINGS
- FACE DETECTION ON/OFF
- AF RANGE LIMITER
- FOCUS CHECK LOCK
- SPORTS FINDER MODE
- PRE-SHOT  
- SELF-TIMER
- AE BKT SETTING
- FOCUS BKT SETTING
- PHOTOMETRY
- SHUTTER TYPE
- FLICKER REDUCTION
- ISO
- IS MODE
- WIRELESS COMMUNICATION
- FLASH COMPENSATION
- FLASH FUNCTION SETTING
- TTL-LOCK
- MODELING FLASH
- FULL HD HIGH SPEED REC
- FIX MOVIE CROP MAGNIFICATION 
-  IS MODE BOOST
- ZEBRA SETTING
- INTERNAL/EXTERNAL MIC LEVEL ADJUSTMENT
- MOVIE OPTIMIZED CONTROL 
- VIEW MODE SETTING
- PREVIEW DEPTH OF FIELD
- PREVIEW EXP./WB IN MANUAL MODE
- NATURAL LIVE VIEW
- HISTOGRAM
- ELECTRONIC LEVEL
- LARGE INDICATORS MODE
- F-Log VIEW ASSIST
- PERFORMANCE
- AUTO IMAGE TRANSFER
- SELECT PAIRING DESTINATION
- Bluetooth ON/OFF
- QUICK MENU
- PLAYBACK
- NONE

 To disable touch-function gestures, choose **NONE**.

10 Peripherals and Optional Accessories

Lenses

The camera can be used with lenses for the FUJIFILM X-mount.

Lens Parts

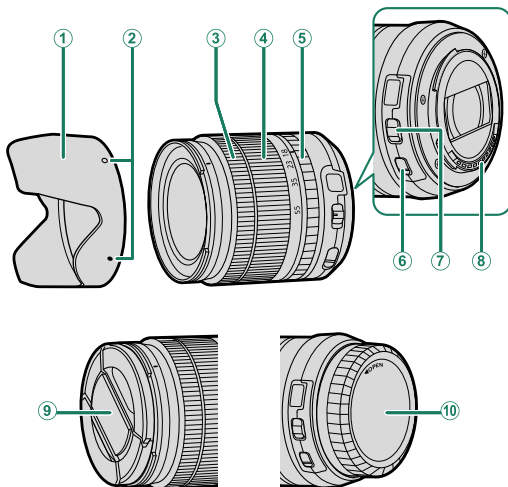

- ① Lens hood
- ② Mounting marks
- ③ Focus ring
- ④ Zoom ring
- ⑤ Aperture ring

- ⑥ O.I.S. switch
- ⑦ Aperture mode switch
- ⑧ Lens signal contacts
- ⑨ Front lens cap
- ⑩ Rear lens cap

 A XF18-55mmF2.8-4 R LM OIS lens is used here for illustrative purposes.

Removing Lens Caps

Remove lens caps as shown.

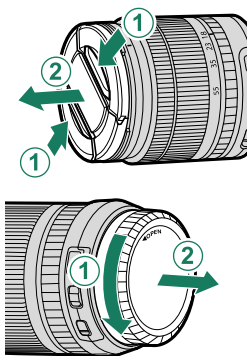

 Lens caps may differ from those shown.

Attaching Lens Hoods

When attached, lens hoods reduce glare and protect the front lens element.

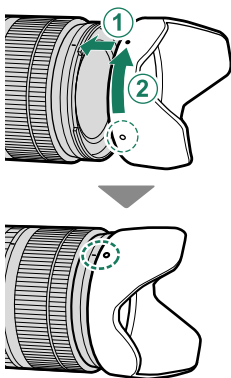

Lenses with Aperture Rings

At settings other than **A**, you can adjust aperture by rotating the lens aperture ring (exposure modes **A** and **M**).

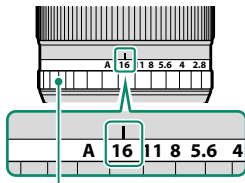

Aperture ring

- Selecting **ON** for **MOVIE OPTIMIZED CONTROL**  disables the aperture ring.
- When the aperture ring is set to **A**, rotate the command dials to adjust aperture.

The Aperture Mode Switch

If the lens has an aperture mode switch, aperture can be adjusted manually by sliding the switch to  and rotating the aperture ring.

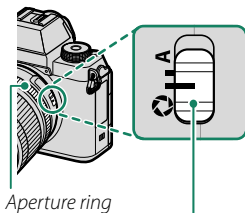

Aperture ring

Aperture mode switch

Lenses with O.I.S. Switches

If the lens supports optical image stabilization (O.I.S.), the image stabilization mode can be chosen in the camera menus. To activate image stabilization, slide the O.I.S. switch to **ON**.

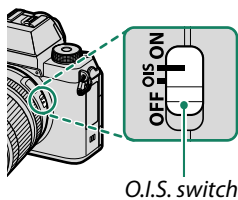

Manual Focus Lenses

Slide the focus ring to the front for auto-focus.

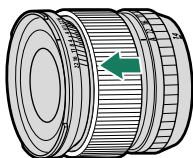

For manual focus, slide the focus ring to the back and rotate it while checking the results in the camera display. The focus distance and depth-of-field indicators can be used to assist manual focus.

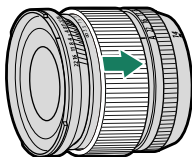

! Note that manual focus may not be available in all shooting modes.

The Depth-of-Field Indicator

The depth-of-field indicator shows the approximate depth of field (the distance in front of and behind the focus point that appears to be in focus). The indicator is displayed in film format.

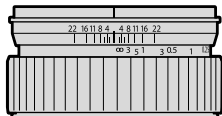

Lens Care



- Use a blower to remove dust, then gently wipe with a soft, dry cloth. Any remaining stains can be removed by wiping gently with a piece of Fujifilm lens-cleaning paper to which a small amount of lens-cleaning fluid has been applied.
- Replace the front and rear caps when the lens is not in use.

External Flash Units

Use optional external flash units for flash photography. Some units support high-speed sync (FP) and can be used at shutter speeds faster than the flash sync speed, while others can function as commanders controlling remote units via optical wireless flash control.

 You may be unable to test-fire the flash in some circumstances, for example when camera menus are displayed.

Red-Eye Removal

Red-eye removal is available when an option other than **OFF** is selected for  **FLASH SETTING** > **RED EYE REMOVAL** and  **AF/MF SETTING** > **FACE/EYE DETECTION SETTING** is **FACE DETECTION ON**. Red-eye removal minimizes “red-eye” caused when light from the flash is reflected from the subject’s retinas.

Flash Sync Speed

The flash will synchronize with the shutter at shutter speeds of $\frac{1}{180}$ s or slower.

Optional Flash Units from Fujifilm

The camera can be used with optional Fujifilm shoe-mounted flash units.

Third-Party Flash Units

Do not use third-party flash units that apply over 300 V to the camera hot shoe.

Using an External Flash

- 1 Connect the unit to the camera.
- 2 In shooting mode, select **FLASH FUNCTION SETTING** in the **FLASH SETTING** menu tab. The options available vary with the flash unit.

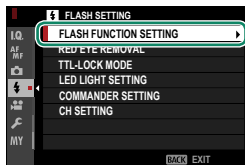

Menu	Description	
Built-In Flash	Displayed when the built-in flash is raised.	101
SYNC TERMINAL	Sync terminal options will be displayed if the built-in flash is lowered and either no flash unit, or an incompatible flash unit, is mounted on the hot shoe.	266
SHOE MOUNT FLASH	Displayed when an optional flash unit other than the EF-X8 is mounted on the hot shoe and turned on.	267
COMMANDER (OPTICAL)	Displayed if an optional flash unit functioning as a commander for Fujifilm optical wireless remote flash control is connected and turned on.	270

- 3 Highlight items using the focus stick (focus lever) and rotate the rear command dial to change the highlighted setting.

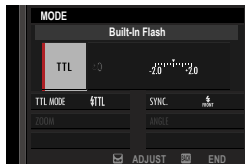

- 4 Press **DISP/BACK** to put the changes into effect.

SYNC TERMINAL

SYNC TERMINAL is displayed if the built-in flash is lowered and either no flash unit, or an incompatible flash unit, is mounted on the hot shoe.

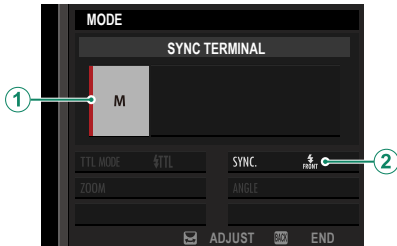





Setting	Description
① Flash control mode	Choose from the following options: <ul style="list-style-type: none">• M: A trigger signal is transmitted via the hot shoe X contacts when a picture is taken. Choose a shutter speed slower than the sync speed; even slower speeds may be required if the unit uses long flashes or has a slow response time.• OFF (OFF): The trigger signal is disabled.
② Sync	Choose whether the flash is timed to fire immediately after the shutter opens (FRONT/1ST CURTAIN) or immediately before it closes (REAR/2ND CURTAIN). 1ST CURTAIN is recommended in most circumstances.

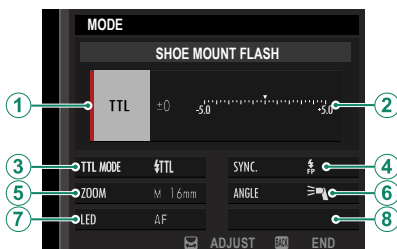







SHOE MOUNT FLASH

The following options are available when an optional shoe-mounted flash unit is attached and turned on.



Setting	Description
1 Flash control mode	<p>The flash control mode selected with the flash unit. This can in some cases be adjusted from the camera; the options available vary with the flash.</p> <ul style="list-style-type: none"> • TTL: TTL mode. Adjust flash compensation (2). • M: The flash fires at the selected output regardless of subject brightness or camera settings. Output in some cases can be adjusted from the camera (2). • MULTI: Repeating flash. Compatible shoe-mounted flash units will fire multiple times with each shot. • OFF (OFF): The flash does not fire. Some flash units can be turned off from the camera.

Setting	Description
<p>② Flash compensation/output</p>	<p>The options available vary with flash control mode.</p> <ul style="list-style-type: none"> • TTL: Adjust flash compensation (the full value may not be applied if the limits of the flash control system are exceeded). In the cases of the EF-X20, EF-20, and EF-42, the selected value is added to the value selected with the flash unit. • M/MULTI: Adjust flash output (compatible units only). Choose from values expressed as fractions of full power, from 1/4 (mode M) or 1/4 (MULTI) down to 1/512 in increments equivalent to 1/3 EV. The desired results may not be achieved at low values if they exceed the limits of the flash control system; take a test shot and check the results.
<p>③ Flash mode (TTL)</p>	<p>Choose a flash mode for TTL flash control. The options available vary with the shooting mode (P, S, A, or M) selected.</p> <ul style="list-style-type: none"> •  (FLASH AUTO): The flash fires only as required; flash level is adjusted according to subject brightness. A  icon displayed when the shutter button is pressed halfway indicates that the flash will fire when the photo is taken. •  (STANDARD): The flash fires with every shot if possible; flash level is adjusted according to subject brightness. The flash will not fire if not fully charged when the shutter is released. •  (SLOW SYNC.): Combine the flash with slow shutter speeds when photographing portrait subjects against a backdrop of night scenery. The flash will not fire if not fully charged when the shutter is released.

Setting	Description
④ Sync	<p>Control flash timing.</p> <ul style="list-style-type: none"> •  (1ST CURTAIN): The flash fires immediately after the shutter opens (generally the best choice). •  (2ND CURTAIN): The flash fires immediately before the shutter closes. •  (AUTO FP(HSS)): High-speed sync (compatible units only). The camera automatically engages front-curtain high-speed sync at shutter speeds faster than the flash sync speed. Equivalent to 1ST CURTAIN when MULTI is selected for flash control mode.
⑤ Zoom	<p>The angle of illumination (flash coverage) for units that support flash zoom. Some units allow the adjustment to be made from the camera. If AUTO is selected, zoom will automatically be adjusted to match coverage to lens focal length.</p>
⑥ Lighting	<p>If the unit supports this feature, choose from:</p> <ul style="list-style-type: none"> •  (FLASH POWER PRIORITY): Gain range by slightly reducing coverage. •  (STANDARD): Match coverage to picture angle. •  (EVEN COVERAGE PRIORITY): Slightly increase coverage for more even lighting.
⑦ LED light	<p>Choose how the built-in LED light functions during still photography (compatible units only): as a catchlight (/CATCHLIGHT), as an AF-assist illuminator (AF/AF ASSIST), or as both a catchlight and an AF-assist illuminator (/AF ASSIST+CATCHLIGHT). Choose OFF to disable the LED during photography.</p>
⑦ Number of flashes *	<p>Choose the number of times the flash fires each time the shutter is released in MULTI mode.</p>
⑧ Frequency *	<p>Choose the frequency at which the flash fires in MULTI mode.</p>

* Full value may not be applied if limits of flash control system are exceeded.

COMMANDER(OPTICAL)

The options will be displayed if the unit is currently functioning as a commander for Fujifilm optical wireless remote flash control.

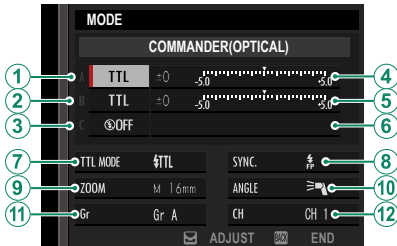





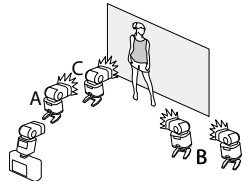





Fujifilm optical wireless remote flash control offers a choice of four channels (Channels 1 through 4) for the exchange of optical signals between the commander and remote flash units. Separate channels can be used for different flash systems or to prevent interference when multiple systems are operating in close proximity.

The flash units can also be placed in up to three groups (A, B, and C) and flash mode and flash level adjusted separately for each group.



Setting	Description
① Flash control mode (group A)	<p>Choose flash control modes for groups A, B, and C. TTL% is available for groups A and B only.</p> <ul style="list-style-type: none"> • TTL: The units in the group fire in TTL mode. Flash compensation can be adjusted separately for each group. • TTL%: If TTL% is selected for either group A or B, you can specify the output of the selected group as a percentage of the other and adjust overall flash compensation for both groups.
② Flash control mode (group B)	<ul style="list-style-type: none"> • M: In mode M, the units in the group fire at the selected output (expressed as a fraction of full power) regardless of subject brightness or camera settings.
③ Flash control mode (group C)	<ul style="list-style-type: none"> • MULTI: Choosing MULTI for any group sets all the units in all groups to repeating flash mode. All units will fire multiple times with each shot. • OFF (OFF): If OFF is selected, the units in the group will not fire.
④ Flash compensation/output (group A)	<p>Adjust flash level for the selected group according to option selected for flash control mode. Note that the full value may not be applied if the limits of the flash control system are exceeded.</p>
⑤ Flash compensation/output (group B)	<ul style="list-style-type: none"> • TTL: Adjust flash compensation.
⑥ Flash compensation/output (group C)	<ul style="list-style-type: none"> • M/MULTI: Adjust flash output. • TTL%: Choose the balance between groups A and B and adjust overall flash compensation.

Setting	Description
7 Flash mode (TTL)	<p>Choose a flash mode for TTL flash control. The options available vary with the shooting mode (P, S, A, or M) selected.</p> <ul style="list-style-type: none"> •  (FLASH AUTO): The flash fires only as required; flash level is adjusted according to subject brightness. A  icon displayed when the shutter button is pressed halfway indicates that the flash will fire when the photo is taken. •  (STANDARD): The flash fires with every shot if possible; flash level is adjusted according to subject brightness. The flash will not fire if not fully charged when the shutter is released. •  (SLOW SYNC.): Combine the flash with slow shutter speeds when photographing portrait subjects against a backdrop of night scenery. The flash will not fire if not fully charged when the shutter is released.
8 Sync	<p>Control flash timing.</p> <ul style="list-style-type: none"> •  (1ST CURTAIN): The flash fires immediately after the shutter opens (generally the best choice). •  (2ND CURTAIN): The flash fires immediately before the shutter closes. •  (AUTO FP(HSS)): High-speed sync (compatible units only). The camera automatically engages front-curtain high-speed sync at shutter speeds faster than the flash sync speed. Equivalent to 1ST CURTAIN when MULTI is selected for flash control mode.
9 Zoom	<p>The angle of illumination (flash coverage) for units that support flash zoom. Some units allow the adjustment to be made from the camera. If AUTO is selected, zoom will automatically be adjusted to match coverage to lens focal length.</p>
10 Lighting	<p>If the unit supports this feature, choose from:</p> <ul style="list-style-type: none"> •  (FLASH POWER PRIORITY): Gain range by slightly reducing coverage. •  (STANDARD): Match coverage to picture angle. •  (EVEN COVERAGE PRIORITY): Slightly increase coverage for more even lighting.

Setting	Description
⑪ Commander	<p>Choose the group for units functioning as a commander for Fujifilm optical wireless remote flash control in TTL, TTL%, or M mode. This option is available only with clip-on flash units that support Fujifilm optical wireless remote flash control.</p> <ul style="list-style-type: none"> • Gr A: Assign the commander to group A. • Gr B: Assign the commander to group B. • Gr C: Assign the commander to group C. • OFF: Output from the commander is held to a level that does not affect the final picture.
⑪ Number of flashes	<p>Choose the number of times the flash fires each time the shutter is released in MULTI mode.</p>
⑫ Channel	<p>Choose the channel used by the commander for communication with the remote flash units. Separate channels can be used for different flash systems or to prevent interference when multiple systems are operating in close proximity.</p>
⑫ Frequency	<p>Choose the frequency at which the flash fires in MULTI mode.</p>

11 Connections

HDMI Output

Camera shooting and playback displays can be output to HDMI devices.

Connecting to HDMI Devices

Connect the camera to TVs or other HDMI devices using a third-party HDMI cable.

- 1 Turn the camera off.
- 2 Connect the cable as shown below.

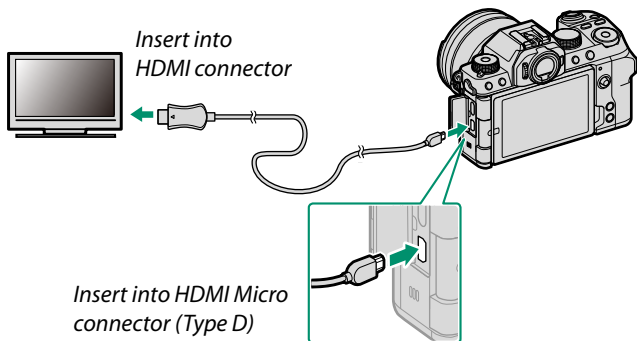

- 3 Configure the device for HDMI input as described in the documentation supplied with the device.
- 4 Turn the camera on. The contents of the camera display will be shown on the HDMI device. The camera display turns off in playback mode (📖 277).

- ! Making sure the connectors are fully inserted.
- Use an HDMI cable no more than 1.5 m (4.9 ft.) long.

Shooting

Shoot photos and record movies while viewing the scene through the camera lens on or saving footage to the HDMI device.

 This feature can be used to save 4K and Full HD movies to an HDMI recorder.

Playback

To start playback, press the camera  button. The camera monitor turns off and pictures and movies are output to the HDMI device. Note that the camera volume controls have no effect on sounds played on the TV; use the television volume controls to adjust the volume.

 Some televisions may briefly display a black screen when movie playback begins.

Wireless Connections (Bluetooth®, Wireless LAN/Wi-Fi)

Access wireless networks and connect to computers, smartphones, or tablets. For more information, visit:

<http://fujifilm-dsc.com/wifi/>



In the text that follows, the term “smartphone” is used to refer to both smartphones and tablets.

Smartphones and Tablets: FUJIFILM Camera Remote

Connect to the camera via Bluetooth or wireless LAN.



To establish a wireless connection to the camera, you will need to install the latest version of the FUJIFILM Camera Remote app on your smartphone or tablet.

FUJIFILM Camera Remote

Once a connection has been established, you can use FUJIFILM Camera Remote to:

- Control the camera and take pictures remotely
- Receive pictures uploaded from the camera
- Browse the pictures on the camera and download selected pictures
- Upload location data to the camera
- Release the camera shutter
- Update camera firmware

For downloads and other information, visit:

http://app.fujifilm-dsc.com/en/camera_remote/

SmartPhones and Tablets: Bluetooth® Pairing

Use **CONNECTION SETTING** > **Bluetooth SETTINGS** > **PAIRING REGISTRATION** to pair the camera with smartphones or tablets. Pairing offers a simple method for downloading photos from the camera.



- Photos are downloaded via a wireless connection.
- Once pairing is complete, you will be able to synchronize the camera clock and location data with the smartphone or tablet (☎ 234).
- You can choose a connection from up to 7 paired smartphones or tablets.

Smartphones and Tablets: Wireless LAN

Establish wireless LAN connections to smartphones or tablets using **WIRELESS COMMUNICATION** in the **SHOOTING SETTING**, **MOVIE SETTING**, or **PLAY BACK MENU**.



Copying Pictures to a Computer: PC AutoSave

Install the latest version of FUJIFILM PC Autosave to your computer to upload pictures from the camera over wireless networks (Wi-Fi).

FUJIFILM PC AutoSave

For downloads and other information, visit:
http://app.fujifilm-dsc.com/en/pc_autosave/

Computers: Wireless Connections

You can upload pictures from the camera using the **PC AUTO SAVE** option in the playback menu.



Connecting via USB

The camera can be connected to computers and smartphones via USB.

Connecting to Computers

 Before downloading pictures or taking pictures remotely, connect the camera to a computer and check that it functions normally.

- 1 Turn the computer on.
- 2 Adjust settings according to whether you will be copying pictures to a computer (📖 284), save RAW pictures in other formats (📖 285), or Saving and Loading Camera Settings (📖 285).
- 3 Turn the camera off.
- 4 Connect a USB cable.

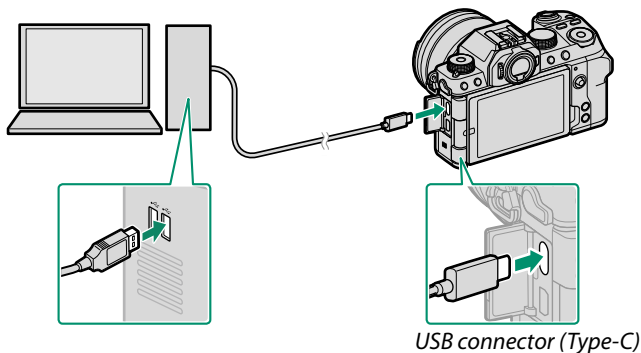

 The USB cable must be no more than 1.5 m (4.9 ft.) long and be suitable for data transfer.

- 5 Turn the camera on.
- 6 Copy pictures to your computer.
 - **Image transfer:** Use applications provided with your operating system.
 - **RAW conversion:** Process RAW images using FUJIFILM X RAW STUDIO. The power of the camera's image processing engine is used for rapid processing.
 - **Saving and loading camera settings:** Use FUJIFILM X Acquire to save or load camera settings. Save your preferred settings to a file in a single operation and copy them to multiple cameras.

- ❗ • Turn the camera off before disconnecting the USB cable.
- When connecting USB cables, be sure the connectors are fully inserted in the correct orientation. Connect the camera directly to the computer; do not use a USB hub or keyboard.
- Loss of power during transfer could result in loss of data or damage to the memory card. Insert a fresh or fully-charged battery before connecting the camera.
- If a memory card containing a large number of images is inserted, there may be a delay before the software starts and you may be unable to import or save images. Use a memory card reader to transfer pictures.
- Make sure that the indicator lamp is off or lit green before disconnecting the camera.
- Do not disconnect the USB cable while transfer is in progress. Failure to observe this precaution could result in loss of data or damage to the memory card.
- Disconnect the camera before inserting or removing memory cards.
- In some cases, it may not be possible to access pictures saved to a network server using the software in the same way as on a stand-alone computer.
- Do not immediately remove the camera from the system or disconnect the USB cable once the message stating that copying is in progress clears from the computer display. If the number of images copied is very large, data transfer may continue after the message has ceased to be displayed.
- The user bears all applicable fees charged by the phone company or Internet service provider when using services that require an Internet connection.

Copying Pictures to a Computer

- Before copying pictures to a computer, select **USB CARD READER** for **CONNECTION SETTING > CONNECTION MODE**.
- The software that can be used to copy pictures varies with your computer operating system.

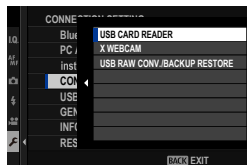

Mac OS X/macOS

Pictures can be copied to your computer using Image Capture (supplied with your computer) or other software.

 Use a card reader to copy files over 4 GB in size.

Windows

Pictures can be copied to your computer using applications supplied with the operating system.

Converting RAW Images: FUJIFILM X RAW STUDIO

- Before proceeding, select **USB RAW CONV./BACKUP RESTORE** for **CONNECTION SETTING > CONNECTION MODE** in the camera menus.
- FUJIFILM X RAW STUDIO can be used to convert RAW images to JPEG or TIFF images.

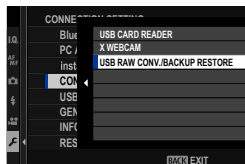

 For more information on FUJIFILM X RAW STUDIO, see “Software for Use with Your Camera” (p. 294).

Backing up and Restoring Camera Settings (FUJIFILM X Acquire)

- Before proceeding, select **USB RAW CONV./BACKUP RESTORE** for **CONNECTION SETTING > CONNECTION MODE** in the camera menus.
- FUJIFILM X Acquire can be used to backup and restore camera settings.

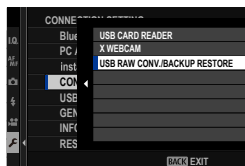

 For more information on FUJIFILM X Acquire, see “Software for Use with Your Camera” (p. 294).

Connecting to Smartphones

To copy pictures to a smartphone, select **OFF** for **CONNECTION SETTING > USB POWER SUPPLY SETTING** and connect the camera to the phone using a USB cable.

For Customers Using Android Devices

How you will connect the camera depends on the type of USB connector with which your smartphone is equipped.

Type-C

Ready a cable equipped with connectors matching the USB (Type-C) connector on the camera.

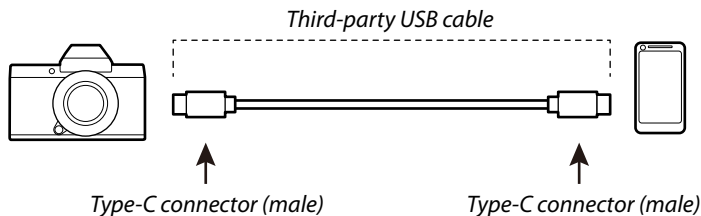

Micro-B

Use a USB on-the-go (OTG) cable.

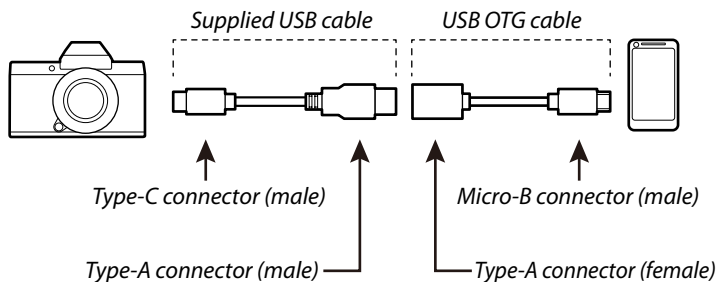

- ! The smartphone must support USB OTG.
- The desired results cannot be achieved with a USB Type-C-to-Micro-B cable. Use an OTG cable.

1 Set the camera's  **CONNECTION SETTING > USB POWER SUPPLY SETTING** to **OFF**.

2 Connect the camera and smartphone using a USB cable.

 If the smartphone asks for permission for an application other than the "Camera Importer" to access the camera, tap "Cancel" and move on to the next step.

3 On your smartphone, tap the notification "Connected to USB PTP".

4 From the recommended applications, select "Camera Importer".

The app will automatically start and allow you to import photos and movies to your smartphone.

 If the message "There is no MTP device connected" appears on the app, please try again from step 2.

For Customers Using iOS

An Apple Lightning to USB Camera Adapter is required.

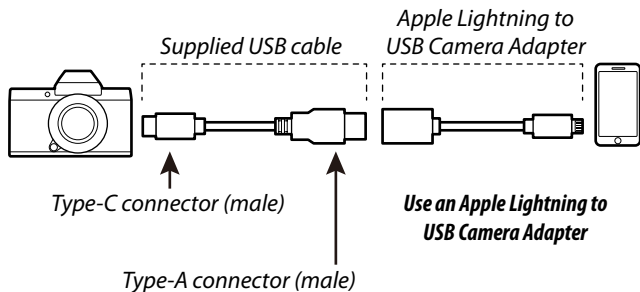

- 1 Set the camera's **CONNECTION SETTING > USB POWER SUPPLY SETTING** to OFF.
- 2 Connect the camera and smartphone using a USB cable. The "Photos" app will automatically start and allow you to import photos and movies to your smartphone.

! The desired results cannot be achieved with a USB Type-C-to-Lightning cable. Use a camera adapter.

instax SHARE Printers

Print pictures from your digital camera to instax SHARE printers.

Establishing a Connection

Select **CONNECTION SETTING** > **instax PRINTER CONNECTION SETTING** and enter the instax SHARE printer name (SSID) and password.

The Printer Name (SSID) and Password

The printer name (SSID) can be found on the bottom of the printer; the default password is "1111". If you have already chosen a different password to print from a smartphone, enter that password instead.

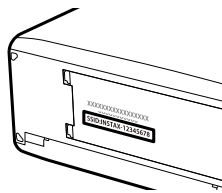

Printing Pictures

- 1 Turn the printer on.
- 2 Select **PLAY BACK MENU > instax PRINTER PRINT**. The camera will connect to the printer.



- 3 Use the focus stick (focus lever) to display the picture you want to print, then press **MENU/OK**.



- Pictures taken with other cameras cannot be printed.
- The area printed is smaller than the area visible in the LCD monitor.
- The displays may vary depending on the printer connected.

- 4 The picture will be sent to the printer and printing will start.

12

Technical Notes

Accessories from Fujifilm

The following optional accessories are available from Fujifilm. For the latest information on the accessories available in your region, check with your local Fujifilm representative or visit <https://fujifilm-x.com/support/compatibility/cameras/>.

Rechargeable Li-ion batteries

NP-W126S: Additional high-capacity NP-W126S rechargeable batteries can be purchased as required.

Battery chargers

BC-W126S: Replacement battery chargers can be purchased as required. At +20 °C/+68 °F, the BC-W126S charges an NP-W126S in about 150 minutes.

AC power adapters

AC-9V (requires CP-W126 DC coupler): Use this 100–240 V, 50/60 Hz AC power adapter for extended shooting and playback or when copying pictures to a computer.

DC couplers

CP-W126: For extended shooting or playback or when using the camera with a computer, use the CP-W126 to connect the camera to the AC-9V power adapter.

Remote releases

RR-100: Use to reduce camera shake or keep the shutter open during a time exposure. The RR-100 has a connector with a diameter of 2.5 mm; a third-party \varnothing 2.5 mm to 3.5 mm adapter is required for connection to the camera.

Stereo microphones

MIC-ST1: An external microphone for movie recording.

FUJINON lenses

XF-/XC-series lenses: Interchangeable lenses for use exclusively with the FUJIFILM X-mount.

FUJINON MKX-series lenses: Cinema lenses for the FUJIFILM X-mount.

Macro extension tubes

MCEX-11/16: Attach between the camera and the lens to shoot at high reproduction ratios.

Teleconverters

XF1.4X TC WR: Increases the focal length of the compatible lenses by about 1.4 \times .

XF2X TC WR: Increases the focal length of the compatible lenses by about 2.0 \times .

Mount adapters

FUJIFILM M MOUNT ADAPTER: Allows the camera to be used with a wide selection of M-mount lenses.

Body caps

BCP-001: Cover the camera lens mount when no lens is attached.

Shoe-mounted flash units

EF-X500: In addition to manual and TTL flash control, this clip-on flash unit has a Guide Number of 50/164 (ISO 100, m/ft.) and supports FP (high-speed sync), allowing it to be used at shutter speeds that exceed the flash sync speed. Featuring support for the optional EF-BP1 battery pack and Fujifilm optical wireless flash control, it can be used as a commander or remote flash unit for remote wireless flash photography.

EF-BP1: A battery pack for EF-X500 flash units. Takes up to 8 AA batteries.

EF-60: In addition to manual and TTL flash control, this clip-on flash unit has a Guide Number of 60/197 (ISO 100, m/ft.) and supports FP (high-speed sync), allowing it to be used at shutter speeds that exceed the flash sync speed. It can also be used as remote flash under the control of an optional EF-W1 wireless commander.

EF-42: This clip-on flash unit has a Guide Number of 42/137 (ISO 100, m/ft.) and supports manual and TTL flash control.

EF-X20: This clip-on flash unit has a Guide Number of 20/65 (ISO 100, m/ft.) and supports manual and TTL flash control.

EF-20: This clip-on flash unit has a Guide Number of 20/65 (ISO 100, m/ft.) and supports TTL flash control (manual flash control is not supported).

EF-W1: With support for the NAS* wireless communication standard developed by Nissin Japan, this wireless flash commander can be used with optional EF-60 clip-on flash units and other NAS-compliant units.

* NAS is a registered trademark of Nissin Japan Ltd.

Grip belts

GB-001: Improves grip. Combine with a hand grip for more secure handling.

instax SHARE printers

SP-1/SP-2/SP-3: Connect via wireless LAN to print pictures on instax film.

Software for Use with Your Camera

The camera can be used with the following software. For the latest information on software available from Fujifilm, visit <https://fujifilm-x.com/support/compatibility/cameras/>.

FUJIFILM Camera Remote

Establish a wireless connection between your camera and a smartphone or tablet (📖 278).

http://app.fujifilm-dsc.com/en/camera_remote/

FUJIFILM PC AutoSave

Download pictures from your camera over wireless networks (📖 280).

http://app.fujifilm-dsc.com/en/pc_autosave/

RAW FILE CONVERTER EX powered by SILKYPIX

RAW FILE CONVERTER EX powered by SILKYPIX is RAW conversion software from Ichikawa Soft Laboratory Co., Ltd. View RAW pictures on your computer and convert them into other formats. RAW FILE CONVERTER EX powered by SILKYPIX is available free of charge from the Fujifilm website.

<https://fujifilm-x.com/support/download/software/raw-file-converter-ex-powered-by-silkypix/>



“RAW FILE CONVERTER EX powered by SILKYPIX” is supplied by Ichikawa Soft Laboratory Co., Ltd.

Capture One Express Fujifilm

Capture One Express Fujifilm is image edit software from Capture One A/S. View RAW pictures on your computer and convert them into other formats. Capture One Express Fujifilm is available free of charge from Capture One.

<https://www.captureone.com/products-plans/capture-one-express/fujifilm>

Capture One Pro Fujifilm

Capture One Pro Fujifilm is workflow software from Capture One A/S. Capture One Pro Fujifilm supports tethered shooting and the conversion of RAW pictures into other formats.

<https://www.captureone.com/explore-features/fujifilm>

FUJIFILM X Acquire

This application for Windows and macOS lets you connect to the camera via USB or Wi-Fi and automatically download photos to a specified folder as they are taken, or backup and restore the camera via USB.

<https://fujifilm-x.com/products/software/x-acquire/>

 Auto download (tethered shooting) is not supported with some cameras.

FUJIFILM X RAW STUDIO

When the camera is connected to a computer via USB, FUJIFILM X RAW STUDIO can use the camera's unique image processing engine to rapidly convert RAW files to create high-quality images in other formats.

<https://fujifilm-x.com/products/software/x-raw-studio/>

FUJIFILM X Webcam

Connect the camera to a computer via USB to turn it into a webcam.

<https://fujifilm-x.com/products/software/x-webcam/>

For Your Safety

IMPORTANT SAFETY INSTRUCTIONS

- **Read Instructions:** All the safety and operating instructions should be read before the appliance is operated.
- **Retain Instructions:** The safety and operating instructions should be retained for future reference.
- **Heed Warnings:** All warnings on the appliance and in the operating instructions should be adhered to.
- **Follow Instructions:** All operating and use instructions should be followed.

Installation

Power Sources: This video product should be operated only from the type of power source indicated on the marking label. If you are not sure of the type of power supply to your home, consult your appliance dealer or local power company. For video products intended to operate from battery power, or other sources, refer to the operating instructions.

Grounding or Polarization: This video product is equipped with a polarized alternating-current line plug (a plug having one blade wider than the other). This plug will fit into the power outlet only one way. This is a safety feature. If you are unable to insert the plug fully into the outlet, try reversing the plug. If the plug should still fail to fit, contact your electrician to replace your obsolete outlet. Do not defeat the safety purpose of the polarized plug.

Alternate Warnings: This video product is equipped with a three-wire grounding-type plug, a plug having a third (grounding) pin. This plug will only fit into a grounding-type power outlet. This is a safety feature. If you are unable to insert the plug into the outlet, contact your electrician to replace your obsolete outlet. Do not defeat the safety purpose of the grounding type plug.

Overloading: Do not overload wall outlets and extension cords as this can result in a risk of fire or electric shock.

Ventilation: Slots and openings in the cabinet are provided for ventilation, to ensure reliable operation of the video product and to protect it from overheating, and these openings must not be blocked or covered. The openings should never be blocked by placing the video product on a bed, sofa, rug, or other similar surface.

This video product should not be placed in a built-in installation such as a bookcase or rack unless proper ventilation is provided or the manufacturer's instructions have been adhered to. This video product should never be placed near or over a radiator or heat register.

Attachments: Do not use attachments not recommended by the video product manufacturer as they may cause hazards.

Water and Moisture: Do not use this video product near water—for example, near a bath tub, wash bowl, kitchen sink, or laundry tub, in a wet basement, or near a swimming pool, and the like.

Power-Cord Protection: Power-supply cords should be routed so that they are not likely to be walked on or pinched by items placed upon or against them, paying particular attention to cords at plugs, convenience receptacles, and the point where they exit from the appliance.

Accessories: Do not place this video product on an unstable cart, stand, tripod, bracket, or table. The video product may fall, causing serious injury to a child or adult, and serious damage to the appliance. Use only with a cart, stand, tripod, bracket, or table recommended by the manufacturer, or sold with the video product. Any mounting of the appliance should follow the manufacturer's instructions, and should use a mounting accessory recommended by the manufacturer.

An appliance and cart combination should be moved with care. Quick stops, excessive force, and uneven surfaces may cause the appliance and cart combination to overturn.



Antennas

Outdoor Antenna Grounding: If an outside antenna or cable system is connected to the video product, be sure the antenna or cable system is grounded so as to provide some protection against voltage surges and built-up static charges. Section 810 of the National Electrical Code, ANSI/NFPA No. 70, provides information with respect to proper grounding of the mast and supporting structure, grounding of the lead-in wire to an antenna discharge unit, size of grounding conductors, location of antenna discharge unit, connection to grounding electrodes, and requirements for the grounding electrode.

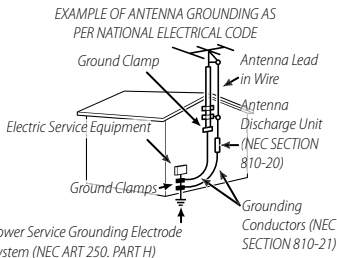

Power Lines: An outside antenna system should not be located in the vicinity of overhead power lines or other electric light or power circuits, or where it can fall into such power lines or circuits. When installing an outside antenna system, extreme care should be taken to keep from touching such power lines or circuits as contact with them might be fatal.

Use

Cleaning: Unplug this video product from the wall outlet before cleaning. Do not use liquid cleaners or aerosol cleaners. Use a damp cloth for cleaning.

Object and Liquid Entry: Never push objects of any kind into this video product through openings as they may touch dangerous voltage points or short out parts that could result in a fire or electric shock. Never spill liquid of any kind on the video product.

Lightning: For added protection for this video product receiver during a lightning storm, or when it is left unattended and unused for long periods of time, unplug it from the wall outlet and disconnect the antenna or cable system. This will prevent damage to the video product due to lightning and power-line surges.

Service

Servicing: Do not attempt to service this video product yourself as opening or removing covers may expose you to dangerous voltage or other hazards. Refer all servicing to qualified service personnel.

Damage Requiring Service: Unplug this video product from the wall outlet and refer servicing to qualified service personnel under the following conditions:

- When the power-supply cord or plug is damaged
- If liquid has been spilled, or objects have fallen into the video product.
- If the video product has been exposed to rain or water.
- If the video product has been dropped or the cabinet has been damaged.

If the video product does not operate normally follow the operating instructions. Adjust only those controls that are covered by the operating instructions as an improper adjustment of other controls may result in damage and will often require extensive work by a qualified technician to restore the video product to its normal operation.

When the video product exhibits a distinct change in performance — this indicates a need for service.

Replacement Parts: When replacement parts are required, be sure the service technician has used replacement parts specified by the manufacturer or have the same characteristics as the original part. Unauthorized substitutions may result in fire, electric shock or other hazards.

Safety Check: Upon completion of any service or repairs to this video product, ask the service technician to perform safety checks to determine that the video product is in proper operating condition.



Be sure to read these notes before use

Safety Notes



- Make sure that you use your camera correctly. Read these safety notes and your *Basic Manual* carefully before use.
- After reading these safety notes, store them in a safe place.

About the Icons



The icons shown below are used in this document to indicate the severity of the injury or damage that can result if the information indicated by the icon is ignored and the product is used incorrectly as a result.

	WARNING	This icon indicates that death or serious injury can result if the information is ignored.
	CAUTION	This icon indicates that personal injury or material damage can result if the information is ignored.

The icons shown below are used to indicate the nature of the instructions which are to be observed.

	Triangular icons tell you that this information requires attention ("Important").
	Circular icons with a diagonal bar tell you that the action indicated is prohibited ("Prohibited").
	Filled circles with an exclamation mark indicate an action that must be performed ("Required").

The symbols on the product (including the accessories) represent the following:

	AC
	DC
	Class II equipment (The construction of the product is double-insulated.)













WARNING













If a problem arises, turn the camera off, remove the battery, disconnect the USB cable, and unplug the AC power adapter. Continued use of the camera when it is emitting smoke, is emitting any unusual odor, or is in any other abnormal state can cause a fire or electric shock. Contact your Fujifilm dealer.







Do not allow water or foreign objects to enter the camera or connecting cables. Do not use the camera or connecting cables following ingress of fresh or salt water, milk, beverages, detergents, or other liquids. Should liquid find its way into the camera or connecting cables, turn the camera off, remove the battery, disconnect the USB cable, and disconnect and unplug the AC adapter. Continued use of the camera can cause a fire or electric shock. Contact your Fujifilm dealer.









Unplug from power socket

 WARNING	
	Do not use the camera in the bathroom or shower. This can cause a fire or electric shock.
	Never attempt to change or take apart the camera (never open the case). Failure to observe this precaution can cause fire or electric shock.
	Should the case break open as the result of a fall or other accident, do not touch the exposed parts. Failure to observe this precaution could result in electric shock or in injury from touching the damaged parts. Remove the battery immediately, taking care to avoid injury or electric shock, and take the product to the point of purchase for consultation.
	Do not change, heat or unduly twist or pull the connection cord and do not place heavy objects on the connection cord. These actions could damage the cord and cause a fire or electric shock. If the cord is damaged, contact your Fujifilm dealer. Do not use cables with bent connectors.
	Do not place the camera on an unstable surface. This can cause the camera to fall or tip over and cause injury.
	Never attempt to take pictures while in motion. Do not use the camera while walking or driving. This can result in you falling down or being involved in a traffic accident.
	Do not touch any metal parts of the camera during a thunderstorm. This can cause an electric shock due to induced current from the lightning discharge.
	Do not use the battery except as specified. Load the battery as shown by the indicator.
	Do not disassemble, modify, or heat batteries. Do not drop, strike, or throw batteries or otherwise subject them to strong impacts. Do not use batteries that show signs of leaking, deformation, discoloration, or other abnormalities. Use only designated chargers to recharge rechargeable batteries and do not attempt to recharge non-rechargeable Li-ion or alkaline batteries. Do not short batteries or store them with metallic objects. Failure to observe these precautions could result in the batteries overheating, igniting, rupturing, or leaking, causing fire, burns, or other injury.
	Use only batteries or AC power adapters specified for use with this camera. Do not use voltages other than the power supply voltage shown. The use of other power sources can cause a fire.
	If the battery leaks and fluid gets in contact with your eyes, skin or clothing, flush the affected area with clean water and seek medical attention or call an emergency number right away.

 WARNING	
	Do not use the charger to charge batteries other than those specified here. The supplied charger is for use only with batteries of the type supplied with the camera. Using the charger to charge conventional batteries or other types of rechargeable batteries can cause the battery to leak, overheat or burst.
	Using a flash too close to a person's eyes may cause visual impairment. Take particular care when photographing infants and young children.
	Do not remain in prolonged contact with hot surfaces. Failure to observe this precaution could result in low-temperature burns, particularly at high ambient temperatures or with users who suffer from poor circulation or reduced sensation, in which case use of a tripod or similar precautions are recommended.
	Do not leave one part of the body in contact with the product for prolonged periods while the product is on. Failure to observe this precaution could result in low-temperature burns, particularly during prolonged use, at high ambient temperatures, or with users who suffer from poor circulation or reduced sensation, in which case use of a tripod or similar precautions are recommended.
	Do not use in the presence of flammable objects, explosive gases, or dust.
	When carrying the battery, install it in a digital camera or keep it in the hard case. When storing the battery, keep it in the hard case. When discarding, cover the battery terminals with insulation tape. Contact with other metallic objects or batteries could cause the battery to ignite or burst.
	Keep memory cards, hot shoes, and other small parts out of the reach of small children. Children may swallow small parts; keep out of reach of children. Should a child swallow a small part, seek medical attention or call emergency.
	Keep out of reach of small children. Among the elements that could cause injury are the strap, which could become entangled about a child's neck, causing strangulation, and the flash, which could cause visual impairment.
	Follow the directions of airline and hospital personnel. This product generates radio-frequency emissions that could interfere with navigational or medical equipment.
 CAUTION	
	Do not use this camera in locations affected by oil fumes, steam, humidity or dust. This can cause a fire or electric shock.
	Do not leave this camera in places subject to extremely high temperatures. Do not leave the camera in locations such as a sealed vehicle or in direct sunlight. This can cause a fire.

 CAUTION	
	Do not place heavy objects on the camera. This can cause the heavy object to tip over or fall and cause injury.
	Do not move the camera while the AC power adapter is still connected. Do not pull on the connection cord to disconnect the AC power adapter. This can damage the power cord or cables and cause a fire or electric shock.
	Do not cover or wrap the camera or the AC power adapter in a cloth or blanket. This can cause heat to build up and distort the casing or cause a fire.
	Do not use the plug if it is damaged or if it does not fit securely into the outlet. Failure to observe this precaution could result in fire or electric shock.
	When you are cleaning the camera or you do not plan to use the camera for an extended period, remove the battery and disconnect and unplug the AC power adapter. Failure to do so can cause a fire or electric shock.

 CAUTION	
	When charging ends, unplug the charger from the power socket. Leaving the charger plugged into the power socket can cause a fire.
	When a memory card is removed, the card could come out of the slot too quickly. Use your finger to hold it and gently release the card. Injury could result to those struck by the ejected card.
	Request regular internal testing and cleaning for your camera. Build-up of dust in your camera can cause a fire or electric shock. Contact your Fujifilm dealer to request internal cleaning every two years. Please note that this service is not free of charge.
	Danger of explosion if battery is incorrectly replaced. Replace only with the same or equivalent type.
	Batteries (battery pack or batteries installed) shall not be exposed to excessive heat such as sunshine, fire or the like.

The Battery and Power Supply

Note: Check the type of battery used in your camera and read the appropriate sections.

 **WARNING:** Battery shall not be exposed to excessive heat such as sunshine, fire or the like.

The following describes the proper use of batteries and how to prolong their life. Incorrect use can shorten battery life or cause leakage, overheating, fire, or explosion.

Li-ion Batteries

Read this section if your camera uses a rechargeable Li-ion battery.

The battery is not charged at shipment. Charge the battery before use. Keep the battery in its case when not in use.

■ Notes on the Battery

The battery gradually loses its charge when not in use. Charge the battery one or two days before use.

Battery life can be extended by turning the camera off when not in use.

Battery capacity decreases at low temperatures; a depleted battery may not function when cold. Keep a fully charged spare battery in a warm place and exchange as necessary, or keep the battery in your pocket or other warm place and insert it in the camera only when shooting. Do not place the battery in direct contact with hand warmers or other heating devices.

■ Charging the Battery

The battery can be charged using a BC-W126S battery charger (available separately). Charging times will increase at ambient temperatures below +10 °C (+50 °F) or above +35 °C (+95 °F). Do not attempt to charge the battery at temperatures above +40 °C (+104 °F); at temperatures below +5 °C (+41 °F), the battery will not charge.

Do not attempt to recharge a fully charged battery. The battery does not however need to be fully discharged before charging.

The battery may be warm to the touch immediately after charging or use. This is normal.

■ Battery Life

A noticeable decrease in the length of time the battery will hold a charge indicates that it has reached the end of its service life and should be replaced.

■ Storage

If the camera will not be used for an extended period, store it at room temperature with the battery charged to approximately one half to ¾ capacity.

If the camera will not be used for an extended period, remove the battery and store it in a dry place with an ambient temperature of from +15 °C to +25 °C (+59 °F to +77 °F). Do not store in locations exposed to extremes of temperature.

■ Cautions: Handling the Battery

- Do not transport or store with metal objects such as necklaces or hairpins.
- Do not expose to flame or heat.
- Do not disassemble or modify.
- Do not expose to low atmospheric pressures.
- Use with designated chargers only.
- Dispose of used batteries promptly.
- Do not drop or subject to strong physical shocks.
- Do not expose to water.
- Keep the terminals clean.
- The battery and camera body may become warm to the touch after extended use. This is normal.

■ Caution: Disposal

Dispose of used batteries in accord with local regulations. Attention should be drawn to the environmental aspects of battery disposal. Use the apparatus under moderate climate.

Do not mechanically crush or split batteries.

AC Power Adapters

- The AC power adapter is for indoor use only.
- Be sure the cable is securely connected to the camera.
- Turn the camera off before disconnecting the adapter. Disconnect the adapter by the plug, not the cable.
- Do not disassemble.

- Do not expose to high heat and humidity.
- Do not subject to strong physical shocks.
- The adapter may hum or become hot to the touch during use. This is normal.
- If the adapter causes radio interference, reorient or relocate the receiving antenna.

Using the Camera

- Do not aim the camera at extremely bright light sources, including artificial light sources or natural light sources such as the sun in a cloudless sky. Failure to observe this precaution could damage the camera image sensor.
- Strong sunlight focused through the viewfinder may damage the panel of electronic viewfinder (EVF). Do not aim the electronic viewfinder at the sun.

Take Test Shots

Before taking photographs on important occasions (such as at weddings or before taking the camera on a trip), take a test shot and view the results to ensure that the camera is functioning normally. FUJIFILM Corporation cannot accept liability for damages or lost profits incurred as a result of product malfunction.

Notes on Copyright

Unless intended solely for personal use, images recorded using your digital camera system cannot be used in ways that infringe copyright laws without the consent of the owner. Note that some restrictions apply to the photographing of stage performances, entertainments, and exhibits, even when intended purely for personal use. Users are also asked to note that the transfer of memory cards containing images or data protected under copyright laws is only permissible within the restrictions imposed by those copyright laws.

Handling

To ensure that images are recorded correctly, do not subject the camera to impact or physical shocks while images are being recorded.

Liquid Crystal

In the event that the display is damaged, care should be taken to avoid contact with liquid crystal. Take the urgent action indicated should any of the following situations arise:

- **If liquid crystal comes in contact with your skin**, clean the area with a cloth and then wash thoroughly with soap and running water.
- **If liquid crystal enters your eyes**, flush the affected eye with clean water for at least 15 minutes and then seek medical assistance.
- **If liquid crystal is swallowed**, rinse your mouth thoroughly with water. Drink large quantities of water and induce vomiting, then seek medical assistance.

Although the display is manufactured using extremely high-precision technology, it may contain pixels that are always lit or that do not light. This is not a malfunction, and images recorded with the product are unaffected.

Trademark Information

Digital Split Image is a trademark or registered trademark of FUJIFILM Corporation. Digital Micro Prism is a trademark or registered trademark of FUJIFILM Corporation. The typefaces included herein are solely developed by DynaComware Taiwan Inc. Apple, iPhone, iPad, Mac, OS X, macOS and Lightning are registered trademarks of Apple Inc. in the U.S.A. and other countries. Windows is a registered trademark of Microsoft Corporation in the U.S.A. and other countries. Android is a trademark or registered trademark of Google LLC. Adobe, the Adobe logo, Photoshop, and Lightroom are trademarks or registered trademarks of Adobe Systems Incorporated in the U.S.A. and other countries. Wi-Fi® and Wi-Fi Protected Setup® are registered trademarks of the Wi-Fi Alliance. The Bluetooth® word mark and logos are registered trademarks owned by the Bluetooth SIG, Inc., and any use of such marks by Fujifilm is under license. The SDHC and SDXC logos are trademarks of SD-3C, LLC. The HDMI logo is a trademark or registered trademark of HDMI Licensing LLC. All other trade names mentioned in this manual are the trademarks or registered trademarks of their respective owners.

Electrical Interference

This camera may interfere with hospital or aviation equipment. Consult with hospital or airline staff before using the camera in a hospital or on an aircraft.

Color Television Systems

NTSC (National Television System Committee) is a color television telecasting specification adopted mainly in the U.S.A., Canada, and Japan. PAL (Phase Alternation by Line) is a color television system adopted mainly in European countries and China.

Exif Print (Exif Version 2.32)

Exif Print is a newly revised digital camera file format in which information stored with photographs is used for optimal color reproduction during printing.

IMPORTANT NOTICE: Read Before Using the Software

Direct or indirect export, in whole or in part, of licensed software without the permission of the applicable governing bodies is prohibited.

Lenses and Other Accessories

- Use a screw 4.5 mm or shorter when attaching a tripod.
- Fujifilm will not be held liable for performance issues or damage caused by the use of third-party accessories.

NOTICES

To prevent fire or shock hazard, do not expose the unit to rain or moisture.

Please read the "Safety Notes" and make sure you understand them before using the camera.

Perchlorate Material—special handling may apply. See:

<http://www.dtsc.ca.gov/hazardouswaste/perchlorate>

For Customers in the U.S. A.

**Tested To Comply With FCC Standards
FOR HOME OR OFFICE USE**



Contains IC : 10293A-WMBNBM26A

Contains FCC ID : COF-WMBNBM26A

FCC Statement: This device complies with Part 15 of the FCC Rules. Operation is subject to the following two conditions:

(1) This device may not cause harmful interference, and (2) this device must accept any interference received, including interference that may cause undesired operation.

CAUTION: This equipment has been tested and found to comply with the limits for a Class B digital device, pursuant to Part 15 of the FCC Rules. These limits are designed to provide reasonable protection against harmful interference in a residential installation. This equipment generates, uses, and can radiate radio frequency energy and, if not installed and used in accordance with the instructions, may cause harmful interference to radio communications. However, there is no guarantee that interference will not occur in a particular installation. If this equipment does cause harmful interference to radio or television reception, which can be determined by turning the equipment off and on, the user is encouraged to try to correct the interference by one or more of the following measures:

- Reorient or relocate the receiving antenna.
- Increase the separation between the equipment and receiver.
- Connect the equipment into an outlet on a circuit different from that to which the receiver is connected.
- Consult the dealer or an experienced radio/TV technician for help.

FCC Caution: Any changes or modifications not expressly approved by the party responsible for compliance could void the user's authority to operate this equipment.

This transmitter must not be co-located or operating in conjunction with any other antenna or transmitter.

Radiation Exposure Statement: This device meets the government's requirements for exposure to radio waves. This device is designed and manufactured not to exceed the emission limits for exposure to radio frequency (RF) energy set by the Federal Communications Commission of the U.S. Government.

The exposure standard for wireless device employs a unit of measurement known as the Specific Absorption Rate, or SAR. The SAR limit set by the FCC is 1.6W/kg. Tests for SAR are conducted using standard operating positions accepted by the FCC with the device transmitting at its highest certified power level in all tested frequency bands.

Notes on the Grant: To comply with Part 15 of the FCC Rules, this product must be used with a Fujifilm-specified ferrite-core A/V cable, USB cable, and DC supply cord.



A lithium ion battery that is recyclable powers the product you have purchased. Please call 1-800-8-BATTERY for information on how to recycle this battery.



California Code of Regulations, Title 20, Division 2, Chapter 4, Article 4, Appliance Efficiency Regulations, Sections 1601 through 1609

For Customers in Canada

CAN ICES-3 (B)/NMB-3(B)

CAUTION: This Class B digital apparatus complies with Canadian ICES-003.

Industry Canada statement: This device complies with Industry Canada's licence-exempt RSSs. Operation is subject to the following two conditions: (1) This device may not cause interference; and (2) This device must accept any interference, including interference that may cause undesired operation of the device.

This device and its antenna(s) must not be co-located or operating in conjunction with any other antenna or transmitter, except tested built-in radios. The County Code Selection feature is disabled for products marketed in the US/ Canada.

Radiation Exposure Statement: The available scientific evidence does not show that any health problems are associated with using low power wireless devices. There is no proof, however, that these low power wireless devices are absolutely safe. Low power Wireless devices emit low levels of radio frequency energy (RF) in the microwave range while being used. Whereas high levels of RF can produce health effects (by heating tissue), exposure of low-level RF that does not produce heating effects causes no known adverse health effects. Many studies of low-level RF exposures have not found any biological effects. Some studies have suggested that some biological effects might occur, but such findings have not been confirmed by additional research. X-S10 has been tested and found to comply with IC radiation exposure limits set forth for an uncontrolled environment and meets RSS-102 of the IC radio frequency (RF) Exposure rules.

Disposal of Electrical and Electronic Equipment in Private Households

In the European Union, Norway, Iceland and

Liechtenstein: This symbol on the product, or in the manual and in the warranty, and/or on its packaging indicates that this product shall not be treated as household waste. Instead it should be taken to an applicable collection point for the recycling of electrical and electronic equipment.



By ensuring this product is disposed of correctly, you will help prevent potential negative consequences to the environment and human health, which could otherwise be caused by inappropriate waste handling of this product.

This symbol on the batteries or accumulators indicates that those batteries shall not be treated as household waste.



If your equipment contains easy removable batteries or accumulators please dispose these separately according to your local requirements.

The recycling of materials will help to conserve natural resources. For more detailed information about recycling this product, please contact your local city office, your household waste disposal service or the shop where you purchased the product.

In Countries Outside the European Union, Norway, Iceland and

Liechtenstein: If you wish to discard this product, including the batteries or accumulators, please contact your local authorities and ask for the correct way of disposal.

In Japan: This symbol on the batteries indicates that they are to be disposed of separately.



Wireless Network and Bluetooth Devices: Cautions

This product complies with the following EU Directives:

- RoHS Directive 2011/65/EU
- RE Directive 2014/53/EU

Hereby, FUJIFILM Corporation declares that the radio equipment type FF200001 is in compliance with Directive 2014/53/EU.

The full text of the EU declaration of conformity is available at the following internet address:

https://dl.fujifilm-x.com/global/products/cameras/x-s10/pdf/x-s10_doc-ngc.pdf

This compliance is indicated by the following conformity marking placed on the product:



This marking is valid for non-Telecom products and EU harmonized Telecom products (e.g. Bluetooth®).

• **Maximum radio-frequency power (EIRP):**

- WLAN: 10.53 dBm
- Bluetooth: 2.54 dBm

IMPORTANT: Read the following notices before using the camera's built-in wireless transmitter.

① This product, which contains encryption function developed in the United States, is controlled by the United States Export Administration Regulations and may not be exported or re-exported to any country to which the United States embargoes goods.

- **Use only a wireless network or Bluetooth device.** Fujifilm does not accept liability for damages resulting from unauthorized use. Do not use in applications requiring a high degree of reliability, for example in medical devices or other systems that may directly or indirectly impact human life. When using the device in computer and other systems that demand a greater degree of reliability than offered by wireless network or Bluetooth devices, be sure to take all necessary precautions to ensure safety and prevent malfunction.
- **Use only in the country in which the device was purchased.** This device conforms to regulations governing wireless network and Bluetooth devices in the country in which it was purchased. Observe all location regulations when using the device. Fujifilm does not accept liability for problems arising from use in other jurisdictions.
- **Do not use the device in locations subject to magnetic fields, static electricity, or radio interference.** Do not use the transmitter in the vicinity of microwave ovens or in other locations subject to magnetic fields, static electricity, or radio interference that may prevent reception of wireless signals. Mutual interference may occur when the transmitter is used in the vicinity of other wireless devices operating in the 2.4 GHz band.
- **The wireless transmitter operates in the 2.4 GHz band using DSSS, OFDM and GFSK modulation.**

- **Security.** Wireless network and Bluetooth devices transmit data via radio and consequently their use requires greater attention to security than applies in the case of wired networks.

- Do not connect to unknown networks or networks to which you do not have access rights, even if they are displayed on your device, as such access may be considered unauthorized. Connect only to networks to which you have access rights.
- Be aware that wireless transmissions may be vulnerable to interception by third parties.
- This device cannot be directly connected to telecommunications networks (including public wireless LANs) operated by providers or mobile, landline, Internet, or other telecommunications services.

- **The following may be punishable by law:**

- Disassembly or modification of this device
- Removal of device certification labels

- **This device operates on the same frequency as commercial, educational, and medical devices and wireless transmitters.** It also operates on the same frequency as licensed transmitters and special unlicensed low-voltage transmitters used in RFID tracking systems for assembly lines and in other similar applications.

- **To prevent interference with the above devices, observe the following precautions.** Confirm that the RFID transmitter is not in operation before using this device. Should you observe that the device causes interference in licensed transmitters used for RFID tracking, immediately stop using the affected frequency or move the device to another location. If you notice that this device causes interference in low-voltage RFID tracing systems, contact a Fujifilm representative.

- **Do not use this device on board an aircraft.** Note that Bluetooth may remain on even when the camera is off. Bluetooth can be disabled by selecting **OFF** for **CONNECTION SETTING > Bluetooth SETTINGS > Bluetooth ON/OFF**.

Be sure to read these notes before using the lens

Safety Notes

- Make sure that you use the lens correctly. Read these safety notes and the camera *Basic Manual* carefully before use.
- After reading these safety notes, store them in a safe place.

About the Icons

The icons shown below are used in this document to indicate the severity of the injury or damage that can result if the information indicated by the icon is ignored and the product is used incorrectly as a result.



WARNING

This icon indicates that death or serious injury can result if the information is ignored.



CAUTION

This icon indicates that personal injury or material damage can result if the information is ignored.

The icons shown below are used to indicate the nature of the instructions which are to be observed.



Triangular icons tell you that this information requires attention ("Important").



Circular icons with a diagonal bar tell you that the action indicated is prohibited ("Prohibited").



Filled circles with an exclamation mark indicate an action that must be performed ("Required").



WARNING



Do not immerse

Do not immerse in or expose to water. Failure to observe this precaution can cause a fire or electric shock.



Do not disassemble

Do not disassemble (do not open the case). Failure to observe this precaution can cause fire, electric shock, or injury due to product malfunction.



Do not touch internal parts

Should the case break open as the result of a fall or other accident, do not touch the exposed parts. Failure to observe this precaution could result in electric shock or in injury from touching the damaged parts. Remove the battery immediately, taking care to avoid injury or electric shock, and take the product to the point of purchase for consultation.



Do not place on unstable surfaces. The product may fall, causing injury.



Do not view the sun through the lens or camera viewfinders. Failure to observe this precaution can cause permanent visual impairment.



CAUTION



Do not use or store in locations that are exposed to steam, or smoke or are very humid or extremely dusty. Failure to observe this precaution can cause fire or electric shock.



Do not leave in direct sunlight or in locations subject to very high temperatures, such as in a closed vehicle on a sunny day. Failure to observe this precaution can cause fire.



Keep out of the reach of small children. This product could cause injury in the hands of a child.



Do not handle with wet hands. Failure to observe this precaution can cause electric shock.



Keep the sun out of the frame when shooting backlit subjects. Sunlight focused into the camera when the sun is in or close to the frame can cause fire or burns.



When the product is not in use, replace the lens caps and store out of direct sunlight. Sunlight focused by the lens can cause fire or burns.



Do not carry the camera or lens while they are attached to a tripod. The product can fall or strike other objects, causing injury.

Product Care

To ensure continued enjoyment of the product, observe the following precautions.

Camera body: Use a soft, dry cloth to clean the camera body after each use. Do not use alcohol, thinner, or other volatile chemicals, which could discolor or deform the leather on the camera body. Any liquid on the camera should be removed immediately with a soft, dry cloth. Use a blower to remove dust from the monitor, taking care to avoid scratches, and then gently wipe with a soft, dry cloth. Any remaining stains can be removed by wiping gently with a piece of Fujifilm lens-cleaning paper to which a small amount of lens-cleaning fluid has been applied. To prevent dust entering the camera, replace the body cap when no lens is in place.

Image sensor: Multiple photographs marred by spots or blotches in identical locations may indicate the presence of dust on the image sensor. Clean the sensor using  **USER SETTING > SENSOR CLEANING.**

Cleaning the Image Sensor

Dust that cannot be removed using **USER SETTING > SENSOR CLEANING** can be removed manually as described below.

! Note that there will be a charge to repair or replace the image sensor if it is damaged during cleaning.

- 1 Use a blower (not a brush) to remove dust from the sensor.

! Do not use a brush or blower brush. Failure to observe this precaution could damage the sensor.

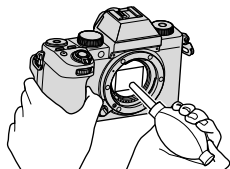

- 2 Check whether the dust has been successfully removed. Repeat Steps 1 and 2 as necessary.
- 3 Replace the body cap or lens.

Firmware Updates

Updates to product firmware may result in changes not described in the manual. For more information, visit: <https://fujifilm-x.com/support/download/firmware/cameras/>

Checking the Firmware Version

 The camera will only display the firmware version if a memory card is inserted.

- 1 Turn the camera off and check that a memory card is inserted.
- 2 Turn the camera on while pressing the **DISP/BACK** button. The current firmware version will be displayed; check the firmware version.
- 3 Turn the camera off.

 To view the firmware version or update firmware for optional accessories such as interchangeable lenses, shoe-mounted flash units, and mount adapters, mount the accessories on the camera.

Troubleshooting

Consult the table below should you encounter problems using your camera. If you don't find the solution here, contact your local Fujifilm distributor.

Power and Battery

Problem	Solution
The camera does not turn on.	<ul style="list-style-type: none">• The battery is exhausted: Charge the battery or insert a fully-charged spare battery (📖 33).• The battery is inserted incorrectly: Reinsert in the correct orientation (📖 30).• The battery-chamber cover is not latched: Latch the battery-chamber cover (📖 30).
The monitor does not turn on.	The monitor may not turn on if the camera is turned off and then on again very quickly. Keep the shutter button pressed halfway until the monitor activates.
The battery runs down quickly.	<ul style="list-style-type: none">• The battery is cold: Warm the battery by placing it in a pocket or other warm place and reinsert it in the camera immediately before taking a picture.• There is dirt on the battery terminals: Clean the terminals with a soft, dry cloth.• ON is selected for  AF/MF SETTING > PRE-AF: Turn PRE-AF off (📖 128).• The camera is in AUTO mode: To extend battery endurance, we recommend that you choose a different mode (📖 56).• The battery has been charged many times: The battery has reached the end of its charging life. Purchase a new battery.
The camera turns off suddenly.	The battery is exhausted: Charge the battery or insert a fully-charged spare battery (📖 33).

Problem	Solution
Charging does not start (USB).	<ul style="list-style-type: none"> • Insert the camera battery (📖 30). • Reinsert the camera battery in the correct orientation (📖 30). • Confirm that the camera is connected to the computer (📖 33). • If the computer is off or in sleep mode, turn on or wake the computer and disconnect and reconnect the USB cable (📖 33).
Charging does not start (battery charger).	<ul style="list-style-type: none"> • Insert the battery. • Reinsert the battery in the correct orientation. • Make sure that the charger is correctly plugged in. • Ensure that the plug adapter is correctly connected to the charger.
Charging is slow.	Charge the battery at room temperature.
The indicator lamp blinks, but the battery does not charge.	<ul style="list-style-type: none"> • There is dirt on the battery terminals: Clean the terminals with a soft, dry cloth (📖 30). • The battery has been charged many times: The battery has reached the end of its charging life. Purchase a new battery. If the battery still fails to charge, contact your Fujifilm dealer (📖 292).
The power supply icon is not displayed.	Confirm that ON is selected for USB POWER SUPPLY SETTING (📖 238).

Menus and Displays

Problem	Solution
Display is not in English.	Select ENGLISH for USER SETTING > 言語/LANG. (📖 39, 208).

Shooting

Problem	Solution
No picture is taken when the shutter button is pressed.	<ul style="list-style-type: none">• The memory card is full: Insert a new memory card or delete pictures (📖 30, 188).• The memory card is not formatted: Format the memory card in the camera (📖 206).• There is dirt on the memory card contacts: Clean the contacts with a soft, dry cloth.• The memory card is damaged: Insert a new memory card (📖 30).• The battery is exhausted: Charge the battery or insert a fully-charged spare battery (📖 33).• The camera has turned off automatically: Turn the camera on (📖 35).• You are using a third-party mount adapter: Select ON for SHOOT WITHOUT LENS (📖 225).
Mottling (“noise”) appears in the monitor or viewfinder when the shutter button is pressed halfway.	Gain is increased to aid composition when the subject is poorly lit and aperture is stopped down, which may result in noticeable mottling when images are previewed in the displays. Images taken with the camera are unaffected.
The camera does not focus.	The subject is not suited to autofocus: Use focus lock or manual focus (📖 86).

Problem	Solution
No panorama is recorded when the shutter button is pressed.	<p>The indicator lamp was orange when you attempted to record a panorama: Wait until the indicator lamps turns off (📖 8).</p>
No face is detected.	<ul style="list-style-type: none"> • The subject's face is obscured by sunglasses, a hat, long hair, or other objects: Remove the obstructions (📖 129). • The subject's face occupies only a small area of the frame: Change the composition so that the subject's face occupies a larger area of the frame (📖 129). • The subject's face is turned away from the camera: Ask the subject to face the camera (📖 129). • The camera is tilted: Keep the camera level. • The subject's face is poorly lit: Shoot in bright light.
The flash does not fire.	<ul style="list-style-type: none"> • The flash is disabled: Adjust settings (📖 148). • The battery is exhausted: Charge the battery or insert a fully-charged spare battery (📖 33). • The camera is in bracketing or continuous mode: Select single frame mode (📖 5). • The flash is lowered: Raise the flash (📖 101).
Some flash modes are not available.	<p>OFF is selected for SOUND & FLASH: Select ON (📖 209).</p>
The flash does not fully light the subject.	<ul style="list-style-type: none"> • The subject is not in range of the flash: Position the subject in range of the flash. • The flash window is obstructed: Hold the camera correctly. • Shutter speed is faster than the sync speed: Choose a slower shutter speed (📖 58, 62, 324).
Pictures are blurred.	<ul style="list-style-type: none"> • The lens is dirty: Clean the lens. • The lens is blocked: Keep objects away from the lens (📖 42). • !AF is displayed during shooting and the focus frame is displayed in red: Check focus before shooting (📖 43).

Problem	Solution
Pictures are mottled.	<ul style="list-style-type: none"><li data-bbox="326 139 919 240">• Shutter speed is slow and the ambient temperature is high: This is normal and does not indicate a malfunction. * Use pixel mapping (📖 119). * X-rays, cosmic rays, and other forms of radiation interacting with the image sensor may cause bright spots of various colors such as white, red, and blue. Pixel mapping helps reduce the occurrence of such bright spots.<li data-bbox="326 385 919 486">• The camera has been used continuously at high temperatures: Turn the camera off and wait for it to cool down (📖 35, 320).<li data-bbox="326 486 919 553">• A temperature warning is displayed: Turn the camera off and wait for it to cool down (📖 35, 320).

Playback

Problem	Solution
Pictures are grainy.	The pictures were taken with a different make or model of camera.
Playback zoom is unavailable.	The pictures were created using RESIZE or with a different make or model of camera.
No sound in movie playback.	<ul style="list-style-type: none"> • Playback volume is too low: Adjust playback volume (📖 212). • The microphone was obstructed: Hold the camera correctly during recording. • The speaker is obstructed: Hold the camera correctly during playback. • OFF is selected for SOUND & FLASH: Select ON (📖 209).
Selected pictures are not deleted.	Some of the pictures selected for deletion are protected.
Pictures remain after ERASE > ALL FRAMES is selected.	Remove protection using the device with which it was originally applied (📖 192).
File numbering is unexpectedly reset.	The battery-chamber cover was opened while the camera was on. Turn the camera off before opening the battery-chamber cover (📖 231).

Connections

Problem	Solution
The monitor is blank.	The camera is connected to a TV: Pictures will be displayed on the TV instead of in the camera monitor (📖 276).
Both the TV and camera monitor are blank.	EVF EVF ONLY +  is selected for VIEW MODE SETTING : Put your eye to the viewfinder or choose a different VIEW MODE SETTING option (📖 14).
No picture or sound on TV.	<ul style="list-style-type: none">• The camera is not properly connected: Connect the camera properly (📖 276).• Input on the television is set to “TV”: Set input to “HDMI” (📖 276).• The volume on the TV is too low: Use the controls on the television to adjust the volume (📖 276).
The computer does not recognize the camera.	Be sure the camera and computer are correctly connected (📖 281).
FUJIFILM X RAW STUDIO or FUJIFILM X Acquire fails to correctly detect the camera.	Check the option selected for CONNECTION MODE on the camera. Select USB RAW CONV./BACKUP RESTORE before connecting the USB cable (📖 285).
Cannot connect to iPhones or iPads.	ON is selected for USB POWER SUPPLY SETTING . Select OFF when the camera is connected via a Lightning connection to a device that do not supply power (📖 238).
Cannot connect to smartphone.	Confirm that the camera is correctly connected : The procedure for connecting the camera varies with the type of connector with which the smartphone is equipped (📖 286).

Wireless Transfer

For additional information on troubleshooting wireless connections, visit:

<https://digitalcamera-support-en.fujifilm.com/>



Problem	Solution
<p>Cannot connect to smartphone. The camera is slow to connect or upload pictures to the smartphone. Upload fails or is interrupted.</p>	<ul style="list-style-type: none"> • The smartphone is too far away: Move the devices closer (📖 278). • Nearby devices are causing radio interference: Move the camera and smartphone away from microwave ovens or cordless phones (📖 278).
<p>Cannot upload images.</p>	<ul style="list-style-type: none"> • The smartphone is connected to another device: The smartphone and camera can connect to only one device at a time. End the connection and try again (📖 278). • There are several smartphones in the vicinity: Try connecting again. The presence of multiple smartphones can make connection difficult (📖 278). • The image was created on another device: The camera may not be able to upload images created on other devices. • The image is a movie: Uploading movies takes some time. In addition, smartphones may not accept upload of movies in formats they do not support.
<p>Smartphone will not display pictures.</p>	<p>Select ON for GENERAL SETTINGS > RESIZE IMAGE FOR SMARTPHONE 📷. Selecting OFF increases upload times for larger images; in addition, some phones may not display images over a certain size (📖 239).</p>

Miscellaneous

Problem	Solution
The camera is unresponsive.	<ul style="list-style-type: none"> • Temporary camera malfunction: Remove and reinsert the battery (📖 30). • The battery is exhausted: Charge the battery or insert a fully-charged spare battery (📖 33). • The camera is connected to a wireless LAN: End the connection.
The camera does not function as expected.	Remove and reinsert the battery (📖 30). If the problem persists, contact your Fujifilm dealer.
Motion in the viewfinder or monitor appears jerky rather than smooth.	When NORMAL is selected for PERFORMANCE , the frame rate will drop if no operations are performed for a set period. The normal frame rate will be restored after you operate camera controls (📖 230).
No sound.	<ul style="list-style-type: none"> • Adjust the volume (📖 211). • OFF is selected for SOUND & FLASH: Select ON (📖 209).
Pressing the Q button does not display the quick menu.	TTL-LOCK is active: End TTL-LOCK (📖 149).







Warning Messages and Displays

The following warnings appear in the display.

Warning	Description
 (red)	Low battery. Charge the battery or insert a fully-charged spare battery.
 (blinks red)	Battery exhausted. Charge the battery or insert a fully-charged spare battery.
!AF (displayed in red with red focus frame)	The camera cannot focus. Use focus lock to focus on another subject at the same distance, then recompose the picture.
Aperture or shutter speed displayed in red	The subject is too bright or too dark and the picture will be over- or under-exposed. Use the flash for additional lighting when taking photographs of poorly-lit subject.
FOCUS ERROR LENS CONTROL ERROR TURN OFF THE CAMERA AND TURN ON AGAIN	Camera malfunction. Turn the camera off and then on again. If the message persists, contact a Fujifilm dealer.
NO CARD	The shutter can only be released when a memory card is inserted. Insert a memory card.
CARD NOT INITIALIZED	<ul style="list-style-type: none">• The memory card is not formatted or the memory card has been formatted in a computer or other device: Format the memory card using  USER SETTING > FORMAT.• The memory card contacts require cleaning: Clean the contacts with a soft, dry cloth. If the message is repeated, format the card. If the message persists, replace the card.• Camera malfunction: Contact a Fujifilm dealer.

Warning	Description
LENS ERROR	Turn the camera off, remove the lens, and clean the mounting surfaces, then replace the lens and turn the camera on. If the problem persists, contact a Fujifilm dealer.
CARD ERROR	<ul style="list-style-type: none"> • The memory card is not formatted for use in the camera: Format the card. • The memory card contacts require cleaning or the memory card is damaged: Clean the contacts with a soft, dry cloth. If the message is repeated, format the card. If the message persists, replace the card. • Incompatible memory card: Use a compatible card. • Camera malfunction: Contact a Fujifilm dealer.
PROTECTED CARD	The memory card is locked. Unlock the card.
BUSY	The memory card is incorrectly formatted. Use the camera to format the card.
 MEMORY FULL	The memory card is full and pictures cannot be recorded. Delete pictures or insert a memory card with more free space.

Warning	Description
WRITE ERROR	<ul style="list-style-type: none"> • Memory card error or connection error: Reinsert the card or turn the camera off and then on again. If the message persists, contact a Fujifilm dealer. • Not enough memory remaining to record additional pictures: Delete pictures or insert a memory card with more free space. • The memory card is not formatted: Format the memory card. • The memory card was removed while data were being recorded: Do not remove the memory card during recording.
FRAME NO. FULL	<p>The camera has run out of frame numbers (current frame number is 999-9999). Insert a formatted memory card and select RENEW for <input checked="" type="checkbox"/> SAVE DATA SET-UP > FRAME NO.. Take a picture to reset frame numbering to 100-0001, then select CONTINUOUS for FRAME NO.</p>
READ ERROR	<ul style="list-style-type: none"> • The file is corrupt or was not created with the camera: The file cannot be viewed. • The memory card contacts require cleaning: Clean the contacts with a soft, dry cloth. If the message is repeated, format the card. If the message persists, replace the card. • Camera malfunction: Contact a Fujifilm dealer.
PROTECTED FRAME	<p>An attempt was made to delete or rotate to a protected picture. Remove protection and try again.</p>

Warning	Description
CAN NOT CROP	The picture is damaged or was not created with the camera.
DPOF FILE ERROR	Print orders can contain no more than 999 pictures. Copy any additional pictures you wish to print to another memory card and create a second print order.
CAN NOT SET DPOF	The picture cannot be printed using DPOF.
 CAN NOT SET DPOF	Movies cannot be printed using DPOF.
CAN NOT ROTATE	The selected picture cannot be rotated.
 CAN NOT ROTATE	Movies cannot be rotated.
 CANNOT EXECUTE	Red-eye removal cannot be applied to movies.
 CANNOT EXECUTE	Red-eye removal cannot be applied to pictures created with other devices.
MISMATCH: 4K MODE AND EXTERNAL MONITOR CHANGE MOVIE MODE	The movie mode selected with the camera is not compatible with the device to which the camera is connected via HDMI. Try selecting a different movie mode (📖 154).
 (yellow)	Turn the camera off and wait for it to cool. Mottling may increase in pictures taken when this warning is displayed.
 (red)	Turn the camera off and wait for it to cool. While this warning is displayed, movie recording may not be available, mottling may increase, and performance, including frame advance rate and display quality, may drop.

Memory Card Capacity

The following table shows the recording time or number of pictures available at different image sizes. All figures are approximate; file size varies with the scene recorded, producing wide variations in the number of files that can be stored. The number of exposures or length remaining may not diminish at an even rate.

		Capacity		16 GB		32 GB	
				FINE	NORMAL	FINE	NORMAL
Photos	3:2			1030	1540	2060	3090
	RAW (UNCOMPRESSED)			270		550	
	RAW (LOSSLESS COMPRESSED)			500		1010	
	RAW (COMPRESSED)			690		1400	
Movies ^{1,2}	4K 2160			20 minutes		40 minutes	
	Full HD 1080			20 minutes		40 minutes	

1 Use a UHS speed class 3 card or better.

2 Assumes default bit rate.

If the memory card has a capacity of over 32 GB, movies will be recorded in single files, regardless of size. If the card has a capacity of 32 GB or less, movies over 4 GB in size will be recorded uninterrupted across multiple files.

Specifications

System																			
Model	FUJIFILM X-S10																		
Product Number	FF200001																		
Effective pixels	Approx. 26.1 million																		
Image sensor	23.5 mm × 15.6 mm (APS-C), X-Trans CMOS sensor with primary color filter																		
Storage media	Fujifilm-recommended SD/SDHC/SDXC memory cards																		
Memory card slot	SD memory card slot (UHS-I compliant)																		
File system	Compliant with Design Rule for Camera File System (DCF2.0), Exif 2.32, and Digital Print Order Format (DPOF)																		
File format	<ul style="list-style-type: none">• Still pictures: Exif 2.32 JPEG (compressed); RAW (original RAF format, uncompressed or compressed using a reversible or non-reversible algorithm; special purpose software required); RAW+JPEG available• Movies: H.264 standard with stereo sound (MOV/MP4)• Audio (voice memos): Stereo sound (WAV)																		
Image size	<table><tbody><tr><td>L 3:2 (6240 × 4160)</td><td>L 1:1 (4160 × 4160)</td></tr><tr><td>L 16:9 (6240 × 3512)</td><td></td></tr><tr><td>M 3:2 (4416 × 2944)</td><td>M 1:1 (2944 × 2944)</td></tr><tr><td>M 16:9 (4416 × 2488)</td><td></td></tr><tr><td>S 3:2 (3120 × 2080)</td><td>S 1:1 (2080 × 2080)</td></tr><tr><td>S 16:9 (3120 × 1760)</td><td></td></tr><tr><td colspan="2">RAW (6240 × 4160)</td></tr><tr><td colspan="2">L panorama: vertical (2160 × 9600)/horizontal (9600 × 1440)</td></tr><tr><td colspan="2">M panorama: vertical (2160 × 6400)/horizontal (6400 × 1440)</td></tr></tbody></table>	L 3:2 (6240 × 4160)	L 1:1 (4160 × 4160)	L 16:9 (6240 × 3512)		M 3:2 (4416 × 2944)	M 1:1 (2944 × 2944)	M 16:9 (4416 × 2488)		S 3:2 (3120 × 2080)	S 1:1 (2080 × 2080)	S 16:9 (3120 × 1760)		RAW (6240 × 4160)		L panorama: vertical (2160 × 9600)/horizontal (9600 × 1440)		M panorama: vertical (2160 × 6400)/horizontal (6400 × 1440)	
L 3:2 (6240 × 4160)	L 1:1 (4160 × 4160)																		
L 16:9 (6240 × 3512)																			
M 3:2 (4416 × 2944)	M 1:1 (2944 × 2944)																		
M 16:9 (4416 × 2488)																			
S 3:2 (3120 × 2080)	S 1:1 (2080 × 2080)																		
S 16:9 (3120 × 1760)																			
RAW (6240 × 4160)																			
L panorama: vertical (2160 × 9600)/horizontal (9600 × 1440)																			
M panorama: vertical (2160 × 6400)/horizontal (6400 × 1440)																			
Lens mount	FUJIFILM X mount																		
Sensitivity	<ul style="list-style-type: none">• Still pictures: Standard output sensitivity equivalent to ISO 160–12800 in increments of 1/3 EV; AUTO; extended output sensitivity equivalent to ISO 80, 100, 125, 25600, or 51200• Movies: Standard output sensitivity equivalent to ISO 160–12800 in increments of 1/3 EV; AUTO; extended output sensitivity equivalent to ISO 25600																		
Metering	256-segment through-the-lens (TTL) metering; MULTI, SPOT, AVERAGE, CENTER WEIGHTED																		

System

Exposure control Programmed AE (with program shift); shutter-priority AE; aperture-priority AE; manual exposure

Exposure compensation

- **Still pictures:** -5 EV +5 EV in increments of 1/3 EV
- **Movies:** -2 EV +2 EV in increments of 1/3 EV

Shutter speed

- **MECHANICAL SHUTTER**
 - **Mode P:** 4 s to 1/4000 s
 - **Mode A:** 30 s to 1/4000 s
 - **Modes S and M:** 15 min. to 1/4000 s
 - **Bulb:** Max. 60 min.
- **ELECTRONIC SHUTTER**
 - **Mode P:** 4 s to 1/32000 s
 - **Mode A:** 30 s to 1/32000 s
 - **Modes S and M:** 15 min. to 1/32000 s
 - **Bulb:** Fixed at 1 s
- **MECHANICAL + ELECTRONIC**
 - **Mode P:** 4 s to 1/32000 s
 - **Mode A:** 30 s to 1/32000 s
 - **Modes S and M:** 15 min. to 1/32000 s
 - **Bulb:** Max. 60 min.







Continuous

CONTINUOUS MODE	Available frame advance rates (JPEG)
30fps(1.25X CROP)*	30
20fps(1.25X CROP)*	20
10fps(1.25X CROP)*	10
20fps*	20
10fps*	10
8.0fps	8.0
5.0fps	5.0
4.0fps	4.0
3.0fps	3.0

* Available with electronic shutter only.

 The frame rate and number of frames per burst varies with shooting conditions and type of memory card used.

System

Focus	<ul style="list-style-type: none">• Mode: Single or continuous AF; manual focus with focus ring• Autofocus system: Intelligent hybrid AF (TTL contrast-detect/phase-detection AF) with AF-assist illuminator• Focus-area selection: SINGLE POINT, ZONE, WIDE/TRACKING, ALL
White balance	Auto (WHITE PRIORITY, AUTO, AMBIENCE PRIORITY), Custom 1, Custom 2, Custom 3, color temperature selection, direct sunlight, shade, daylight fluorescent, warm white fluorescent, cool white fluorescent, incandescent, underwater
Self-timer	Off, 2 sec., 10 sec.
Flash	<ul style="list-style-type: none">• Type: Manual pop-up flash unit• Guide number: Approx. 7/22 (ISO 200, m/ft.)
Flash mode	<ul style="list-style-type: none">• MODE: TTL MODE (FLASH AUTO, STANDARD, SLOW SYNC.), MANUAL, COMMANDER, OFF• SYNC. MODE: 1ST CURTAIN, 2ND CURTAIN, AUTO FP (high-speed sync)• RED EYE REMOVAL:  FLASH+REMOVAL,  FLASH,  REMOVAL, OFF
Hot shoe	Accessory shoe with TTL contacts; supports sync speeds as fast as $\frac{1}{180}$ s
Sync contact	X contact; supports sync speeds as fast as $\frac{1}{180}$ s
Sync terminal	—
Electronic viewfinder (EVF)	0.39-in., 2360k-dot OLED viewfinder; magnification 0.62× with 50 mm lens (35 mm format equivalent) at infinity and diopter set to -1.0 m ⁻¹ ; diagonal angle of view approximately 31° (horizontal angle of view approximately 26°) <ul style="list-style-type: none">• Diopter adjustment: -4 to $+2$ m⁻¹• Eyepoint: Approximately 17.5 mm
LCD monitor	3.0-in./7.6 cm, 1040k-dot color touch screen LCD monitor, Vari-angle LCD monitor
Movies (with stereo sound)	<ul style="list-style-type: none">• Movie size:  16:9,  17:9,  16:9,  17:9• Frame rate: 59.94P, 50P, 29.97P, 25P, 24P, 23.98P• Bit rate: 200Mbps, 100Mbps, 50Mbps• Recording/output format: SD card, 4:2:0, 8-bit/HDMI output, 4:2:2, 10-bit
High-speed movies	<ul style="list-style-type: none">• Movie size: FULL HD 16:9• Frame advance rate: 240P, 200P, 120P, 100P

Input/output terminals**Microphone connector** ø3.5 mm mini-stereo jack**Headphone jack socket** The USB connector can be converted to a headphone jack using the supplied headphone adapter**Remote release connector** ø3.5 mm 3-pole mini jack**Digital input/output** USB connector (Type-C) USB3.2 Gen1x1**HDMI output** HDMI Micro connector (type D)**Power supply/other****Power supply** NP-W126S rechargeable battery (supplied with camera)**Battery life**

- **Battery type:** NP-W126S
- **Lens:** XF35mmF1.4 R
- **External flash units:** Disabled
- **Shooting mode:** Mode P

Number of shots		
PERFORMANCE	LCD	EVF
BOOST	Approx. 260	Approx. 235
NORMAL	Approx. 325	Approx. 300

Total length of footage that can be recorded on a single charge		
Mode	Actual battery life of movie capture	Continuance battery life of movie capture
4K ¹	Approx. 40 minutes	Approx. 55 minutes
FHD ²	Approx. 40 minutes	Approx. 65 minutes
High-speed movies ³	Approx. 40 minutes	—

1 At a frame rate of 29.97 fps.

2 At a frame rate of 59.94 fps.

3 At a frame rate of 120 fps.

CIPA standard. Measured using battery supplied with camera and SD memory card.

Note: Battery endurance varies with battery charge level and the figures given above are not guaranteed. Battery endurance will decline at low temperatures.

Power supply/other

Camera size (W × H × D) 126.0 mm × 85.1 mm × 65.4 mm (32.9 mm excluding projections, measured at thinnest part)/4.96 in. × 3.35 in. × 2.57 in. (1.30 in.)

Camera weight Approx. 415 g/14.6 oz., excluding battery, accessories, and memory card

Shooting weight Approx. 465 g/16.4 oz., including battery and memory card

Operating conditions

- **Temperature:** 0 °C to +40 °C/+32 °F to +104 °F
- **Humidity:** 10% to 80% (no condensation)

Wireless transmitter

Wireless LAN

Standards IEEE 802.11b/g/n (standard wireless protocol)

Operating frequency (center frequency) 2,412 MHz–2,462 MHz (11 channels)

Access protocols Infrastructure

Bluetooth®

Standards Bluetooth version 4.2 (Bluetooth Low Energy)

Operating frequency (center frequency) 2,402 MHz–2,480 MHz

NP-W126S rechargeable battery**Nominal voltage** 7.2 V**Nominal capacity** 1260 mAh**Operating temperature** 0 °C to +40 °C/+32 °F to +104 °F**Dimensions** 36.4 mm × 47.1 mm × 15.7 mm/1.4 in. × 1.9 in. × 0.6 in.
(W × H × D)**Weight** Approx. 47 g/1.7 oz.

Weight and dimensions vary with the country or region of sale.



Specifications and performance are subject to change without notice. Fujifilm will not be held liable for any errors this manual may contain. The appearance of the product may differ from that described in this manual.

FUJIFILM

FUJIFILM Corporation

7-3, AKASAKA 9-CHOME, MINATO-KU, TOKYO 107-0052, JAPAN

<https://fujifilm-x.com>

